

FENDI

for

 **Apple**

Francesco Pimpinicchio

CONCEPT

The capsul collection was born from the idea of a collaboration between two major global companies.

The iconic Fendi logo designed by Karl Lagerfeld, changes and blends with the most famous apple in the world, becoming a characterizing element of the project.

A punk allure mixed with pop colors, details and pivotal elements of the Maison, complete the essential design and sportwear of man and woman accessories.

Thus was born Fendi for Apple

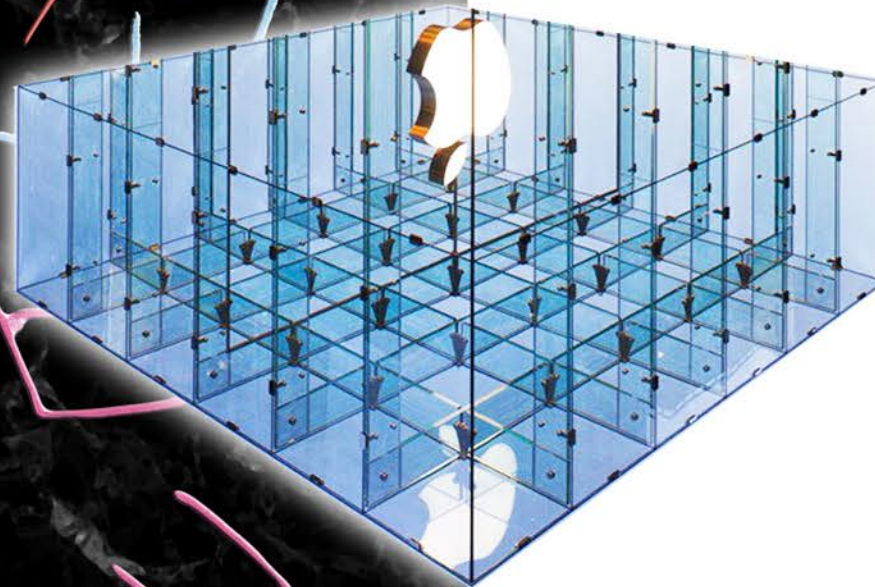

La capsul collection deriva dall'idea di una collaborazione tra due colossi mondiali.

L'iconico logo Fendi disegnato da Karl Lagerfeld, muta e si fonde con la mela più famosa del mondo diventando elemento caratterizzante del progetto.

Un allure punk mixato con colori pop, dettagli ed elementi cardine della Maison, completano il design sportwear e pulito degli accessori uomo donna.

Nasce così Fendi for Apple



FENDI

PROCESSES

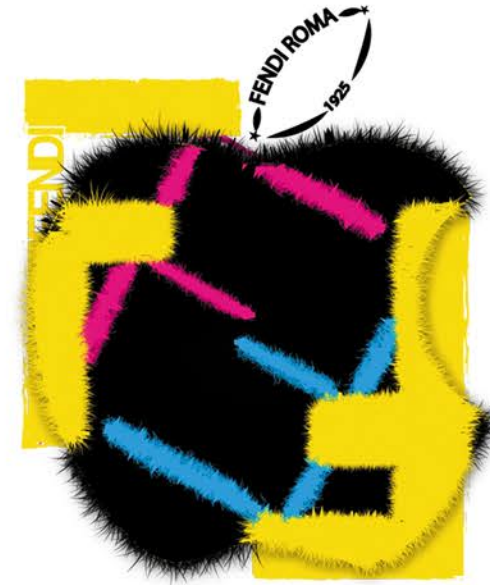
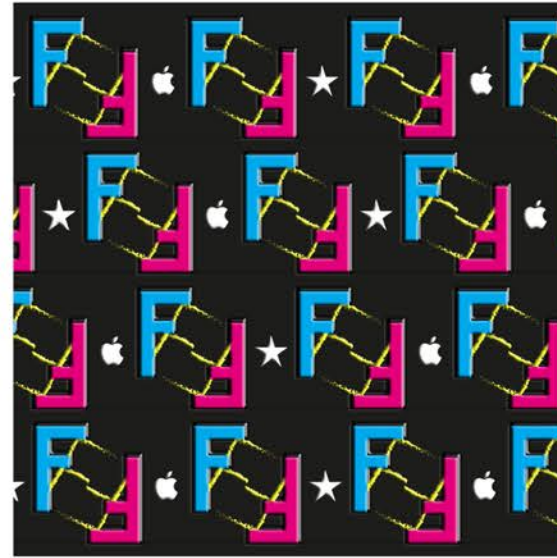

Leather with FF logo embossed

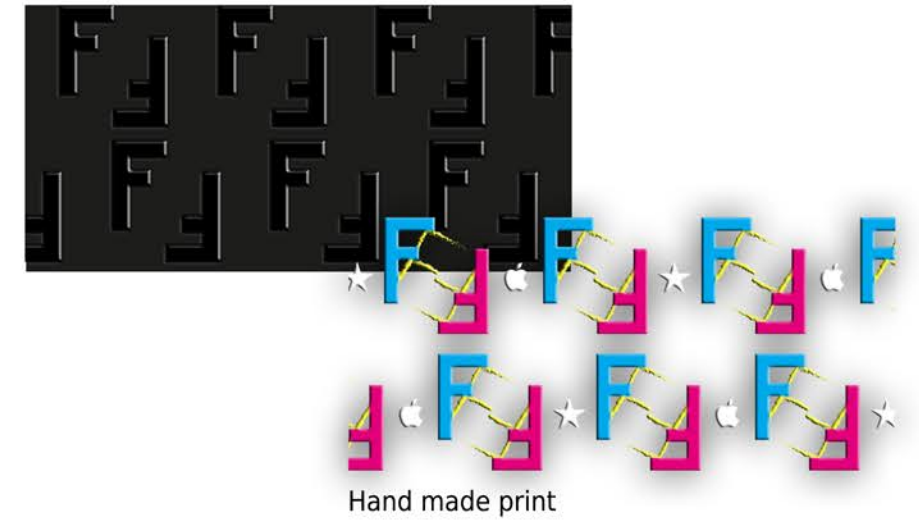

Hand made print

Inlay leather with hand made print



Fur inlay made of mink fur printed with a multi color FF pattern.

Coated fabric with FF pattern

FENDI

METAL HARDWARES

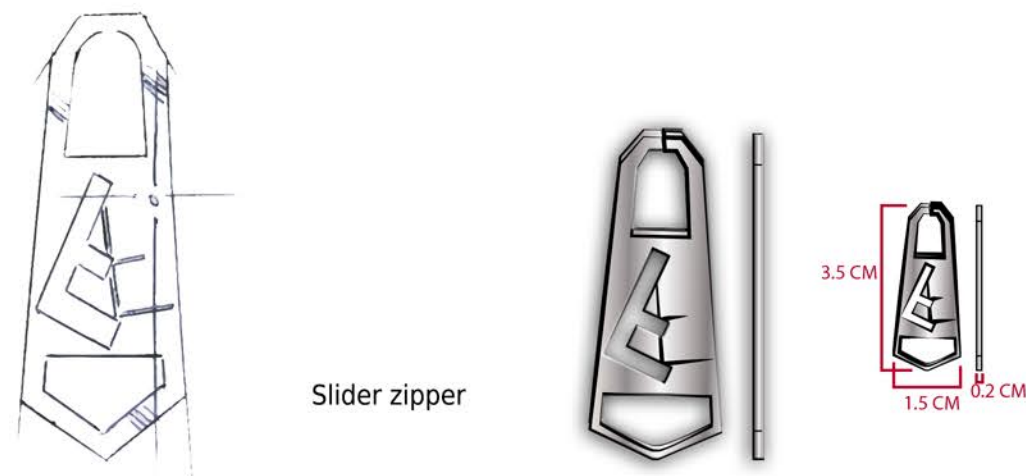
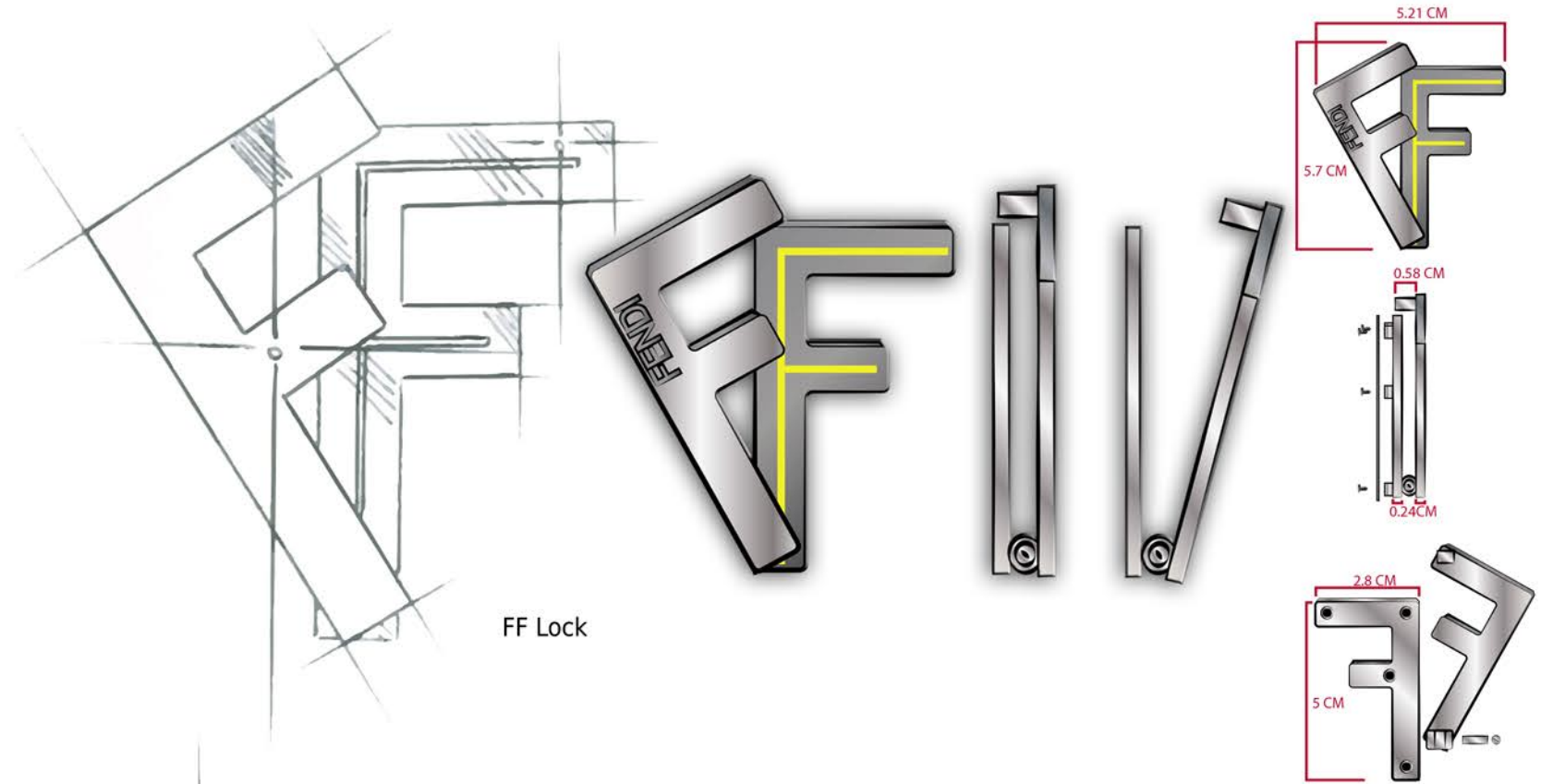

FENDI

BELT BAG

Belt bag made in leather.
Clousere with flap and double FF lock.
Detail on the flap of fur element and embossed FF logo
both in combination with hand made print.

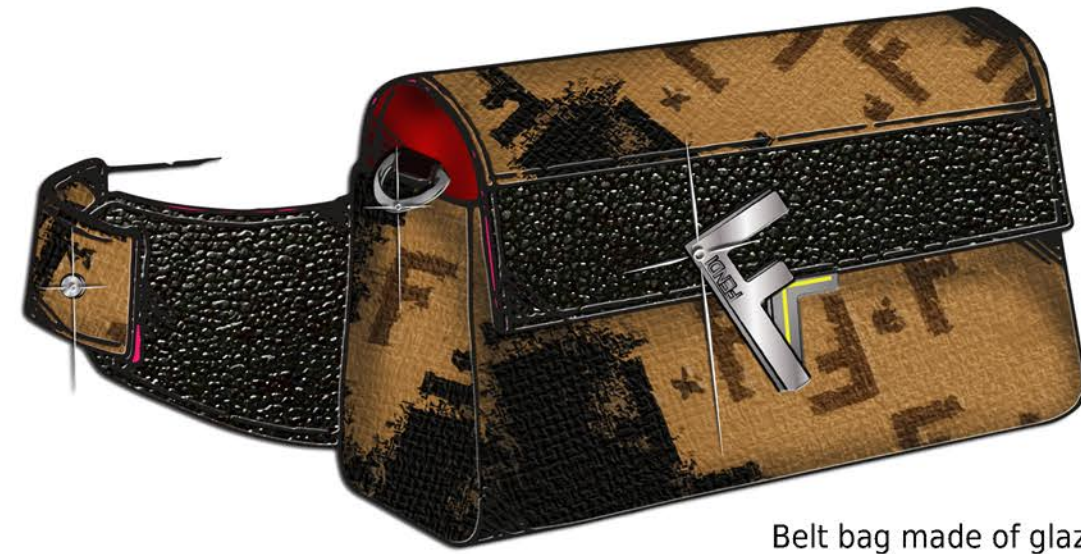

Belt bag made of glazed fabric and leather.
Clousere with flap and double FF lock.

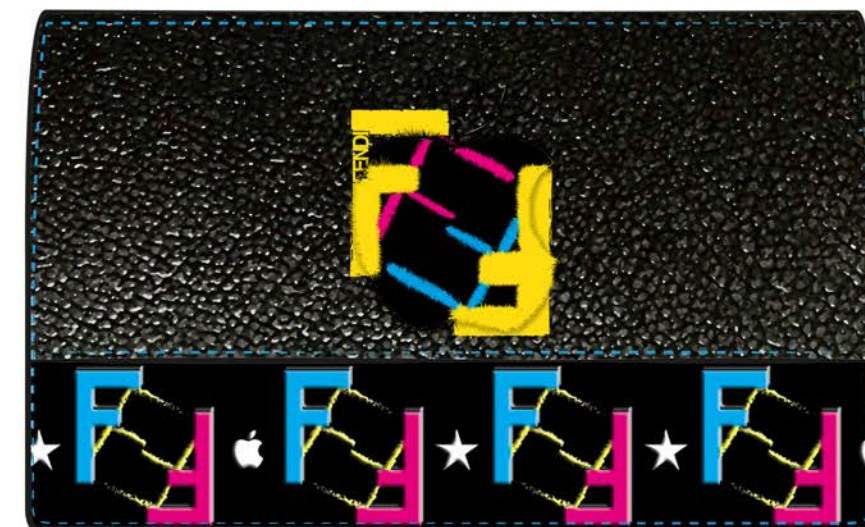
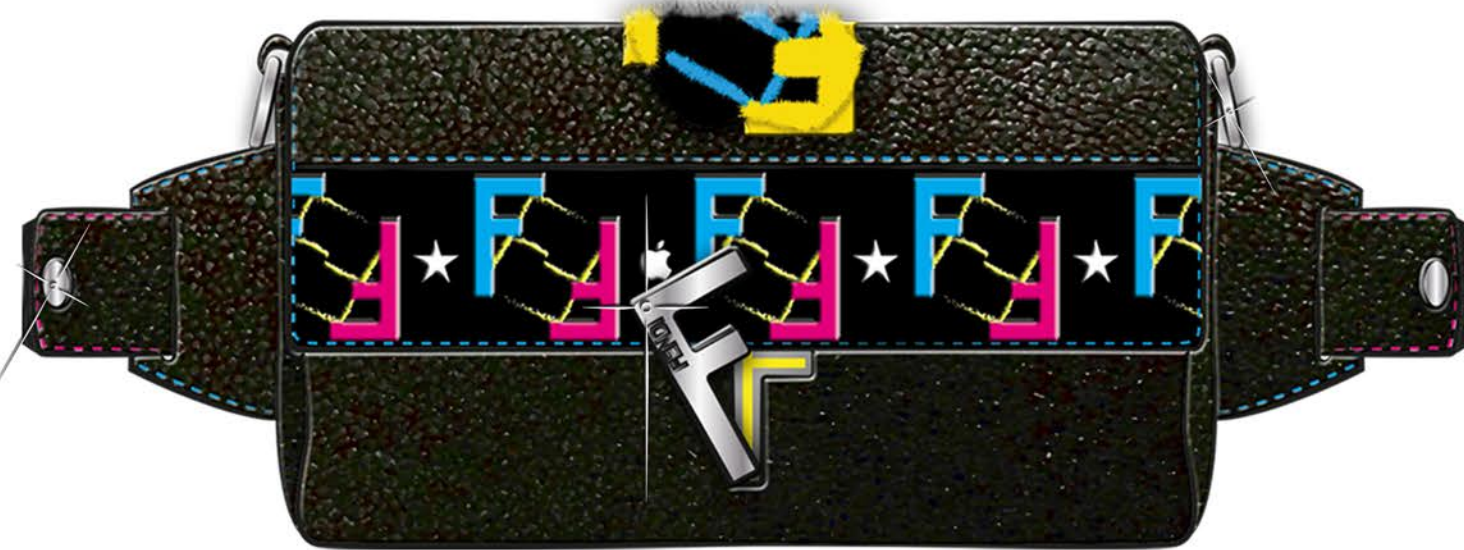
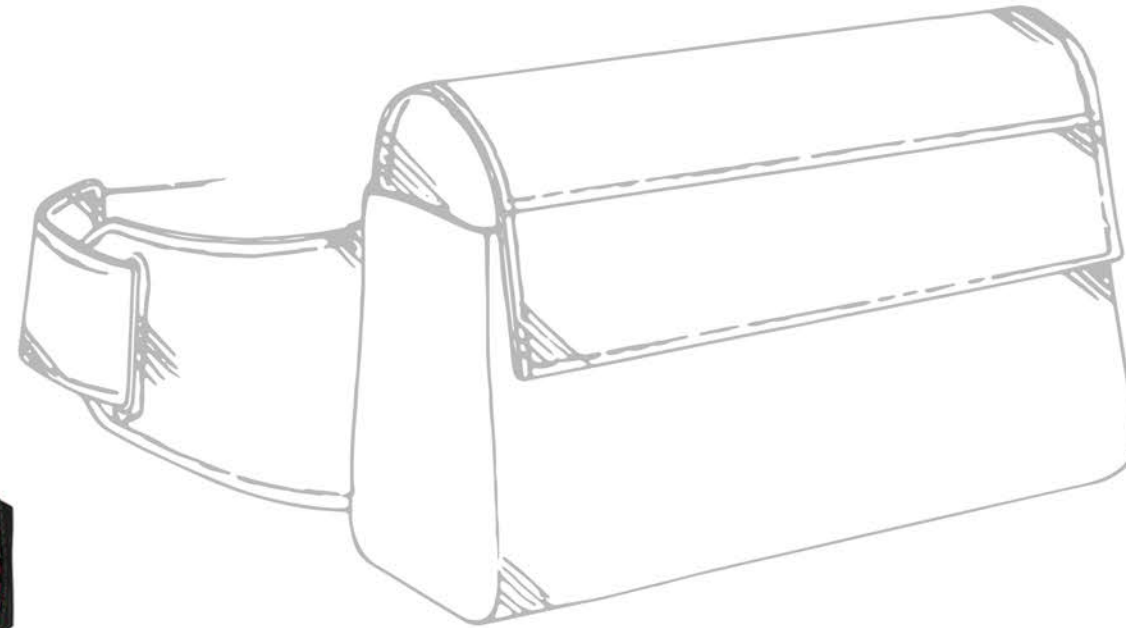

FENDI

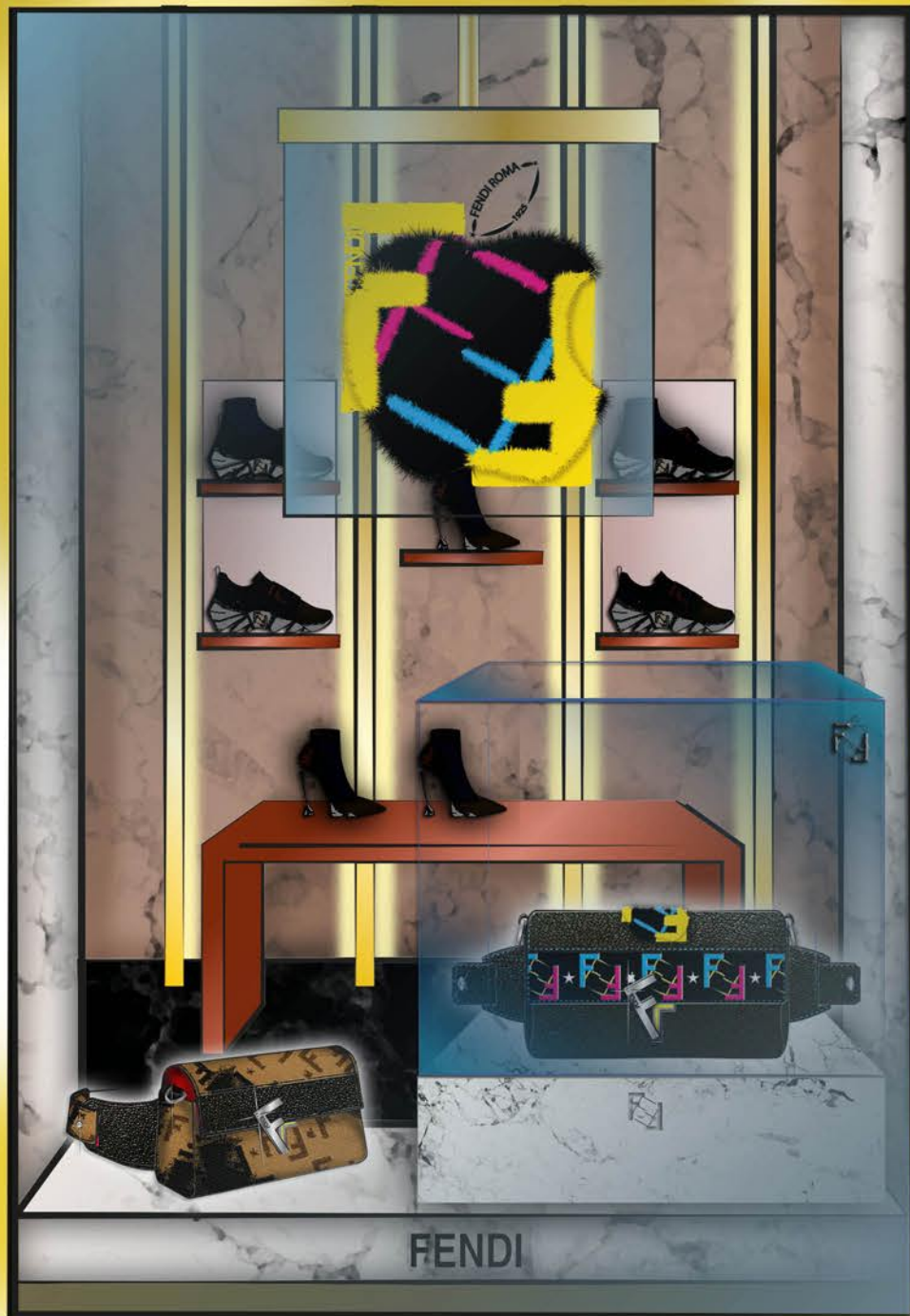

FENDI

BELT BAG

ONE-SHOULDER BACKPACK

One-shoulder backpack made in leather.
Zip fastening with double slider,
fur element in combination with
hand made print; studs in double finishing,
and detail of embossed logo with hand made print.

One-shoulder bag made of glazed fabric and leather

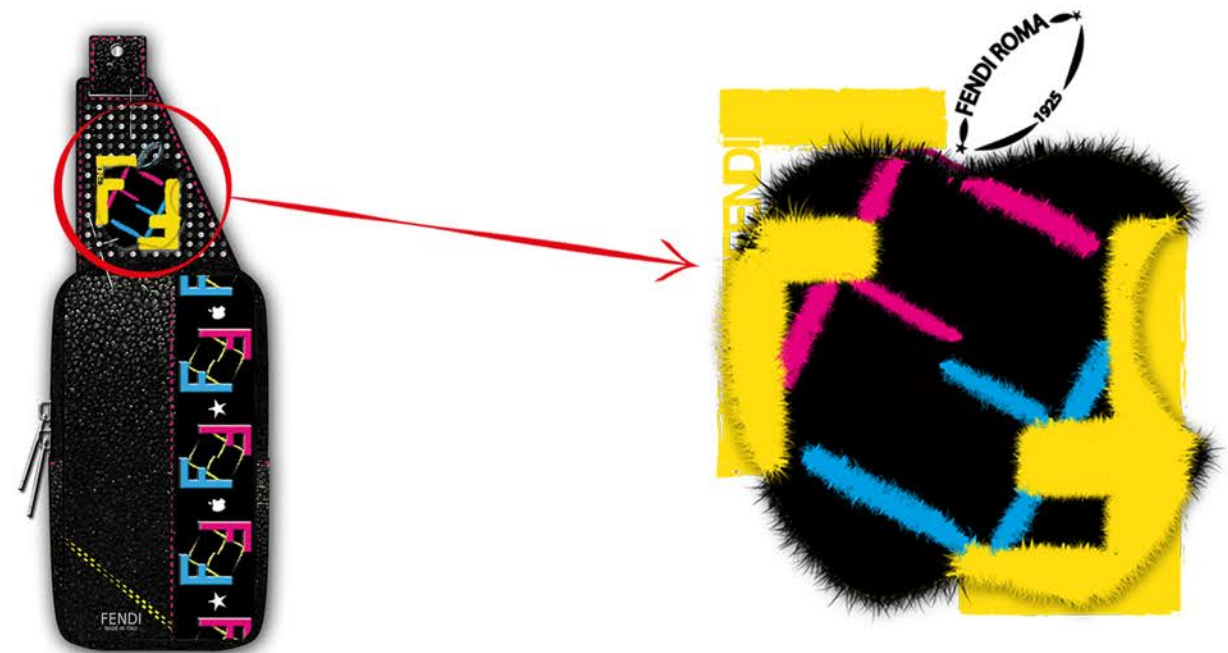
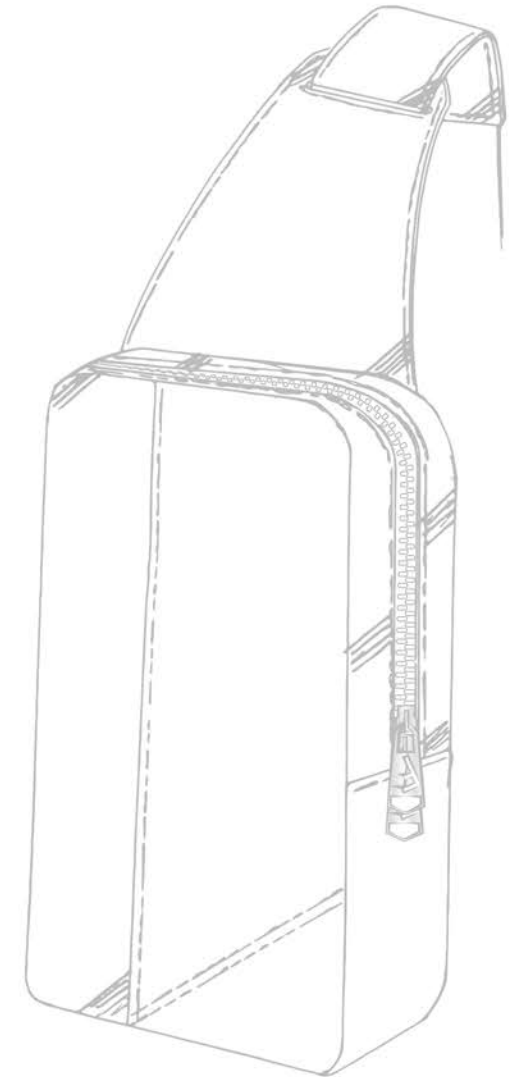



FENDI

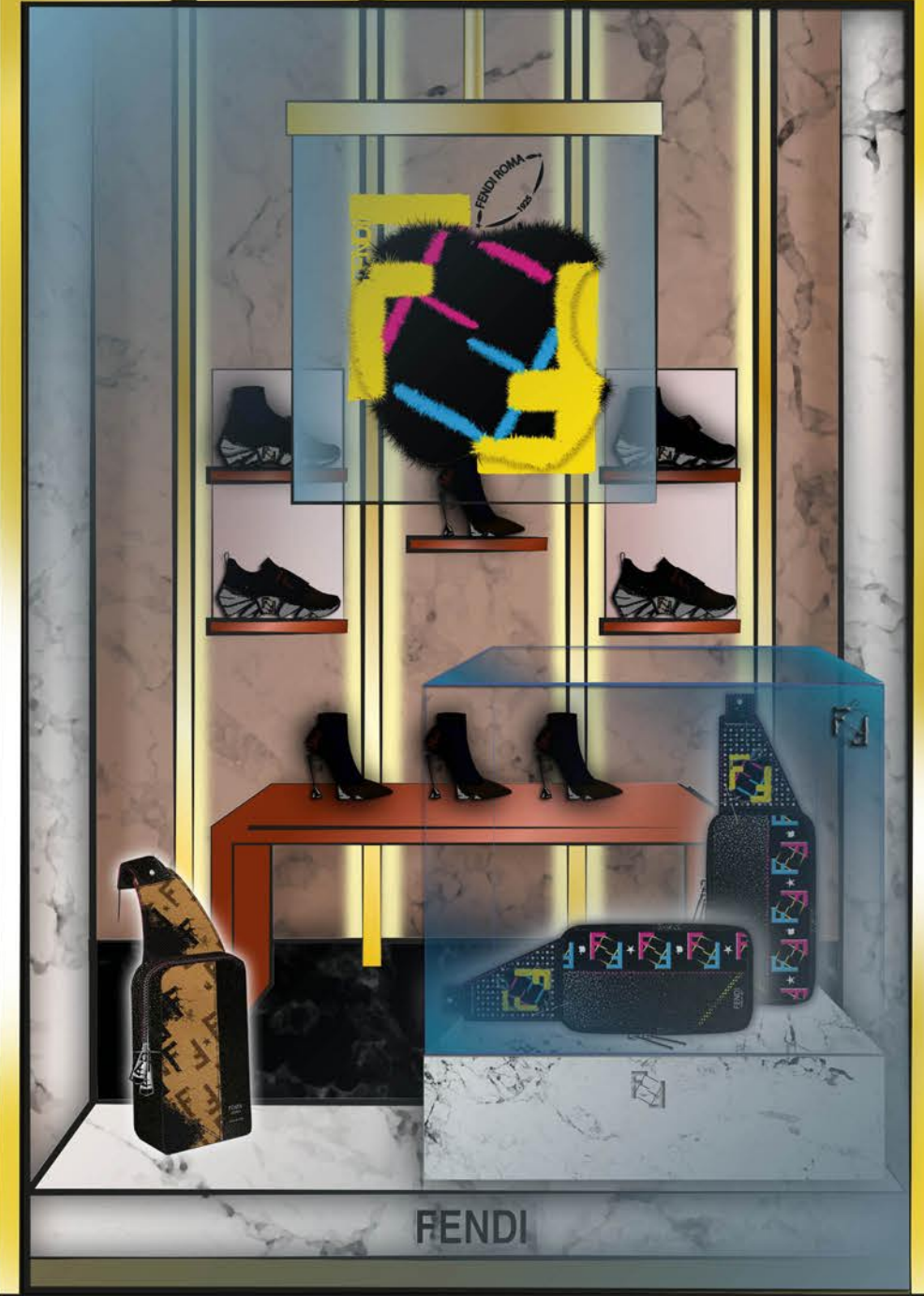

FENDI

FENDI

MESSENGER BAG

Messenger bag made in leather.
Closure with flap and double FF lock and zip fastening.
Detail of fur element and embossed FF logo
both in combination with hand made print.



Messenger bag made of glazed fabric
and leather.
Closure with flap and double FF lock
and zip fastening.

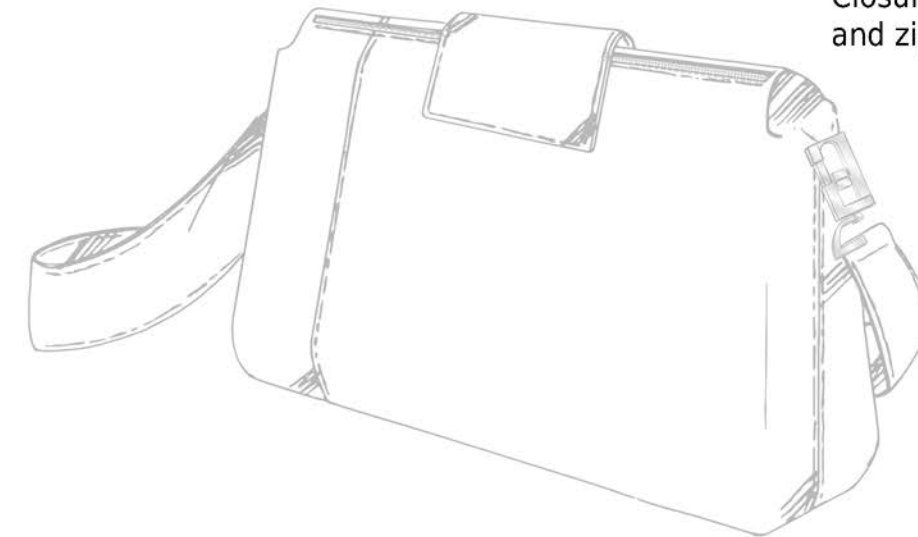

FENDI

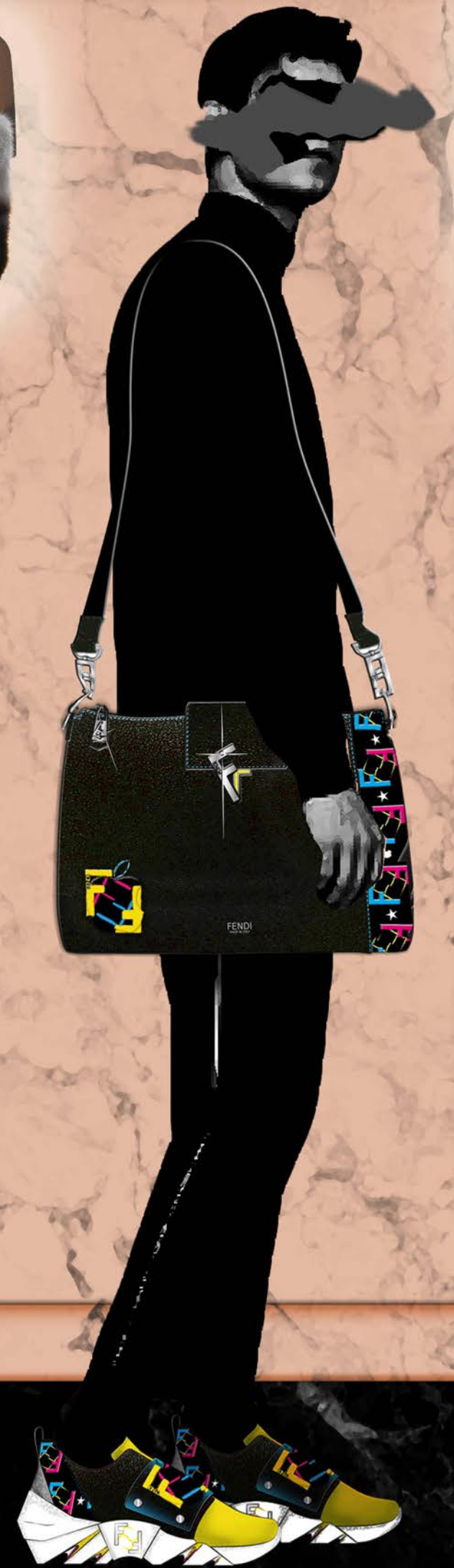
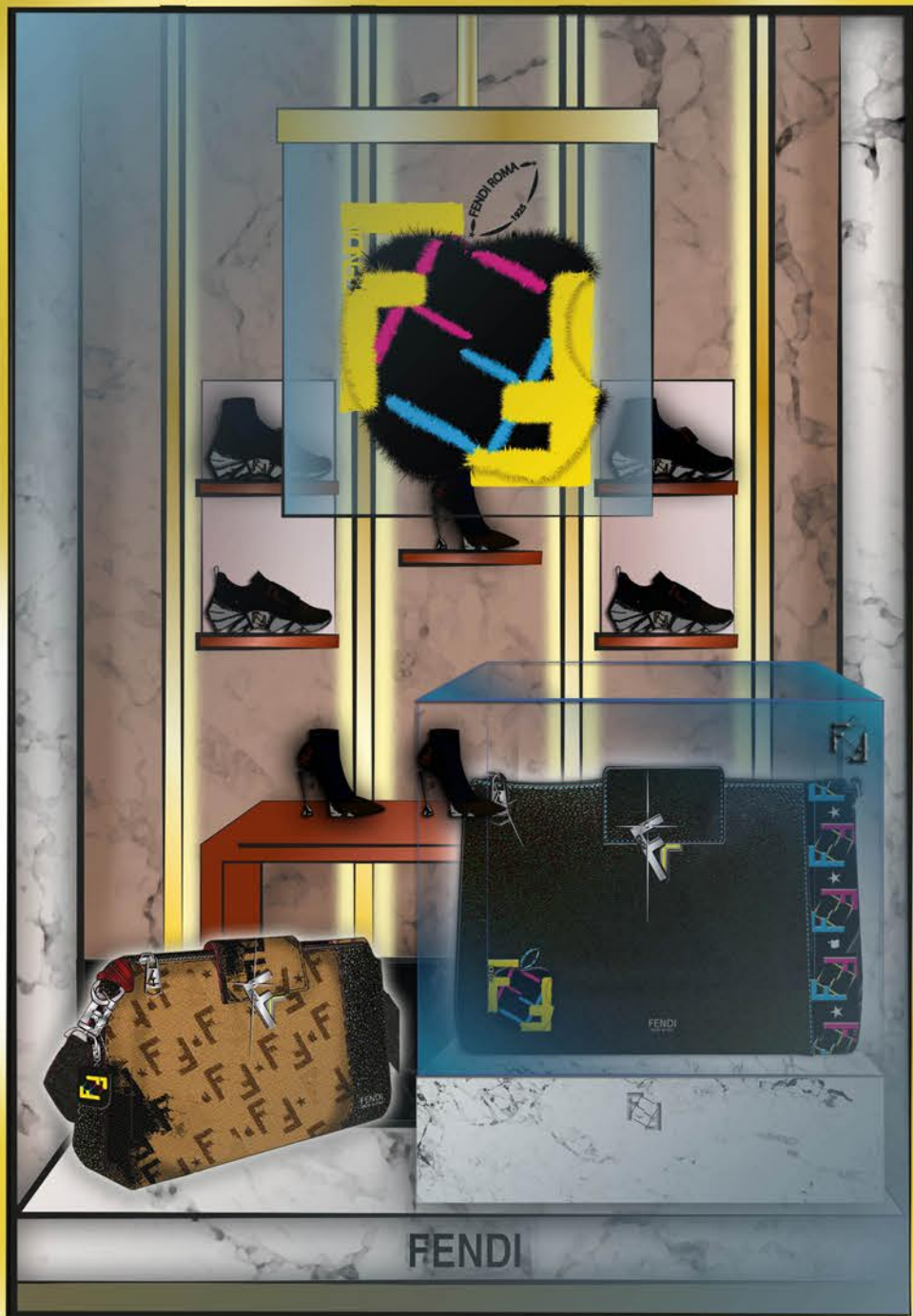

FENDI

BACKPACK

Backpack made in leather.
Zip fastening with double slider, central compartment
and zippered front pocket.
Detail of fur in combination with hand made print,
and studs in double finishing.

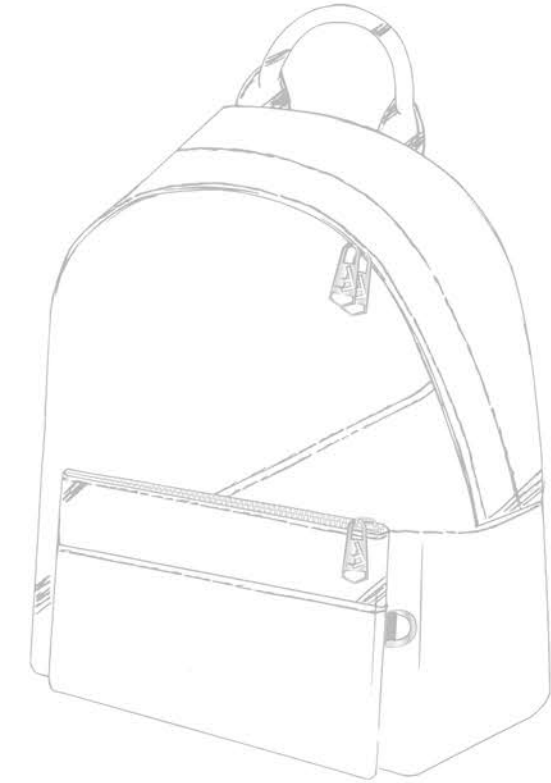

Backpack made of glazed fabric and
leather. with double slider, central compartment
and zippered front pocket.

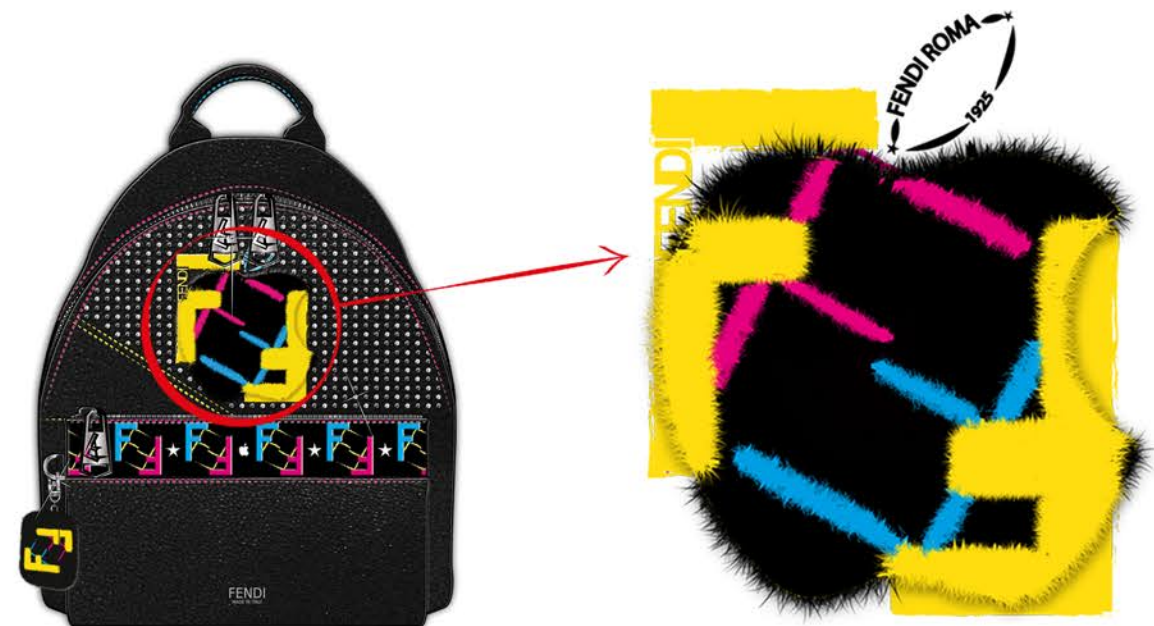



FENDI

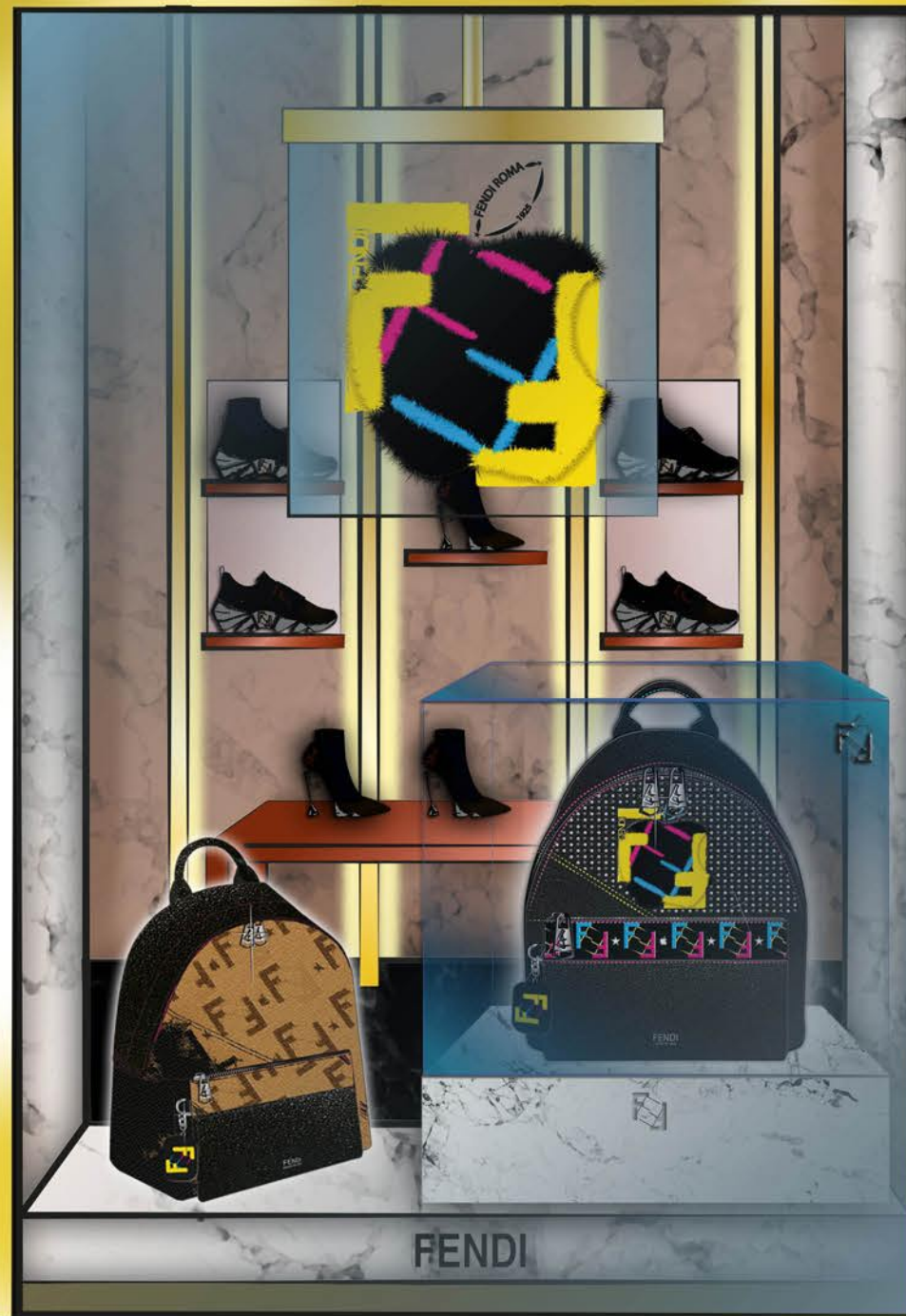

FENDI

FENDI

BACKPACK

Backpack made in leather.
Closure with flap and double FF lock,
central compartment and zippered front pocket.
Detail of fur and embossed FF logo both in combination
with hand made print.

Backpack made of glazed fabric.
Closure with flap and double FF lock,
central compartment and zippered front pocket.

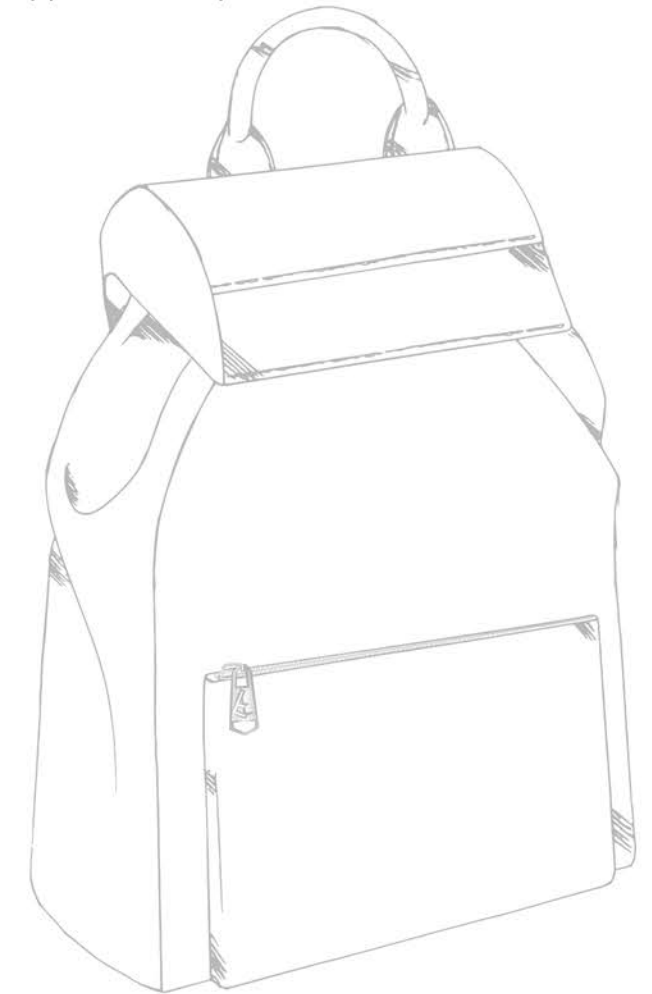

FENDI

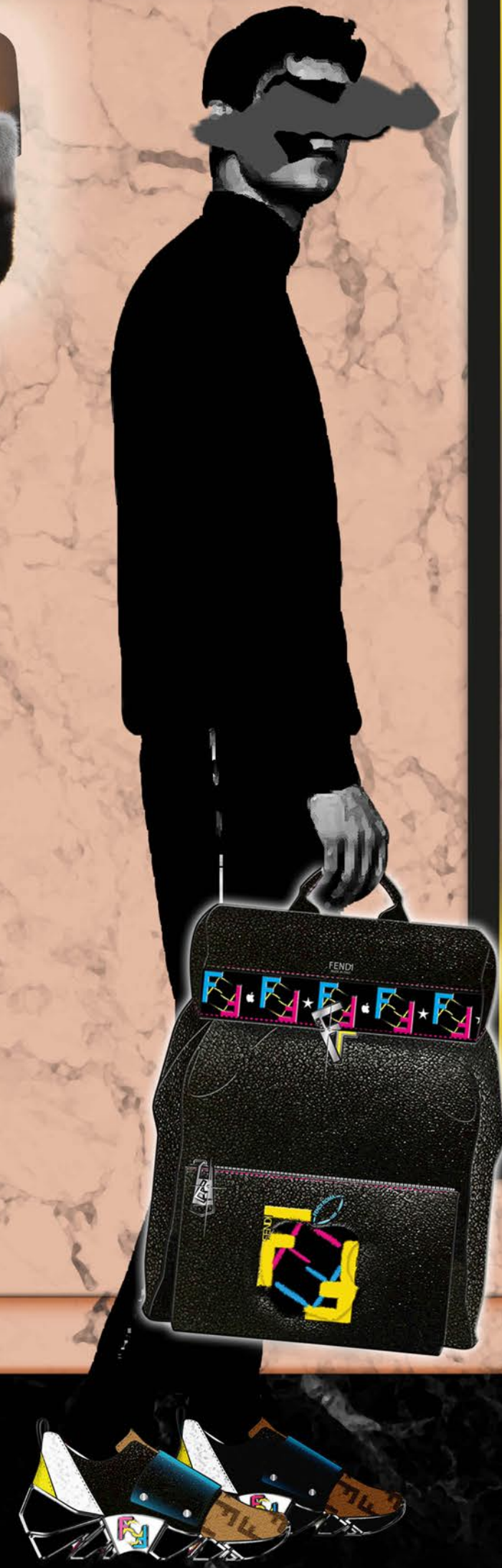

FENDI

TOTES

Leather tote bag with adaptable handle.
Central fur element in combination with
hand made print; handles with embossed
logue and hand made print.



Tote bag made of glazed fabric with
adaptable handle.
The handles and the gusset are made
in leather.

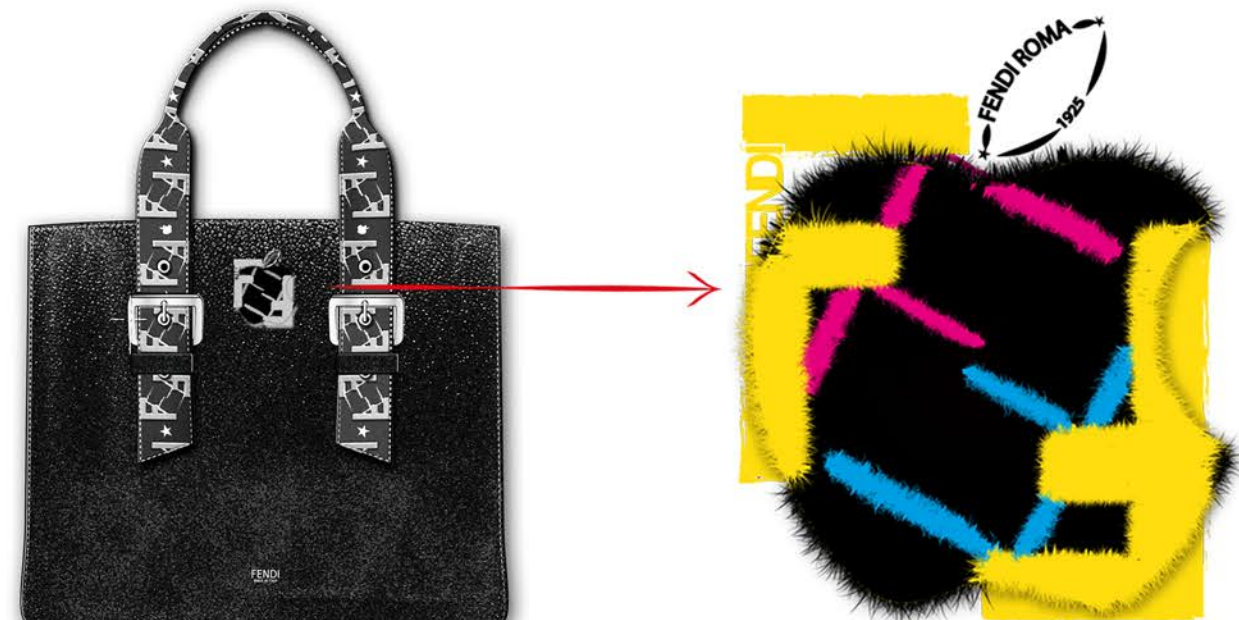



FENDI

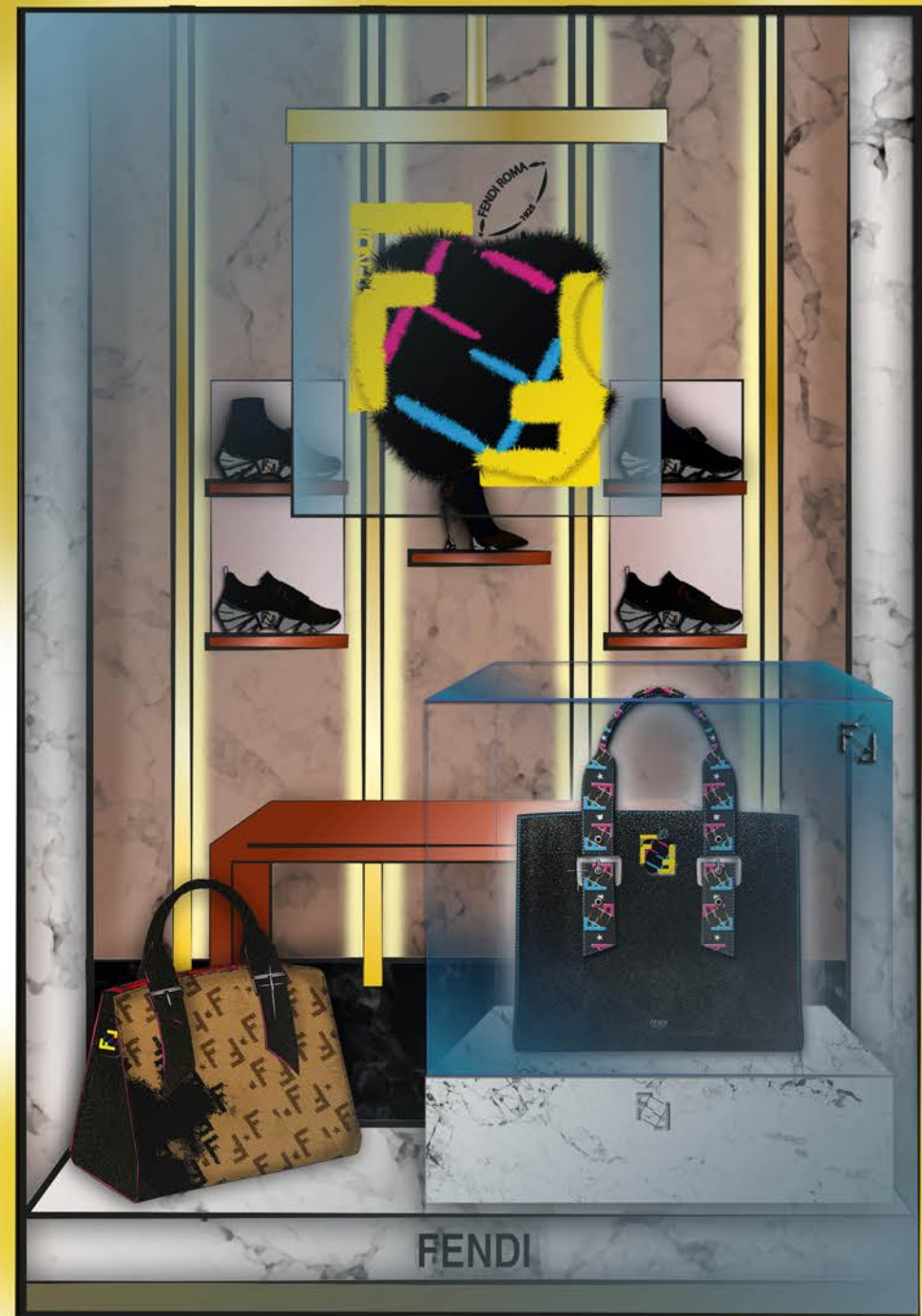

FENDI

FENDI

PEEKABOO X-LITE FIT

Peekaboo X-Lite Fit made in leather.
Zipper pocket on the inside with studs, leather embossed
and hand made print of FF logo.
Fur element on the body.

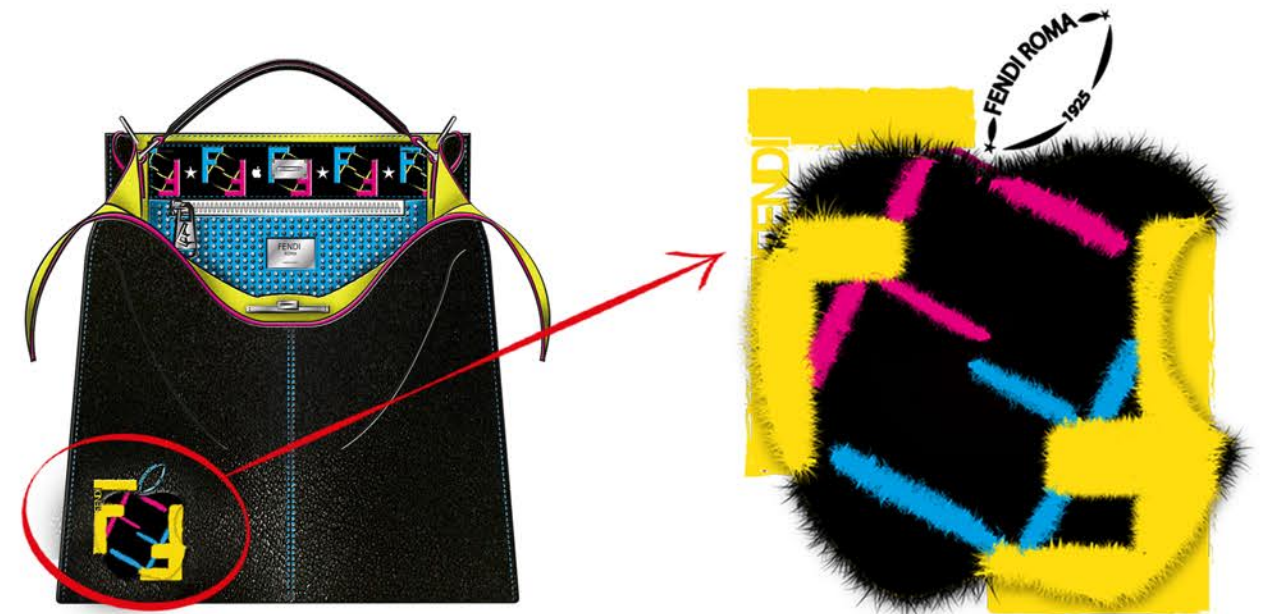

FENDI

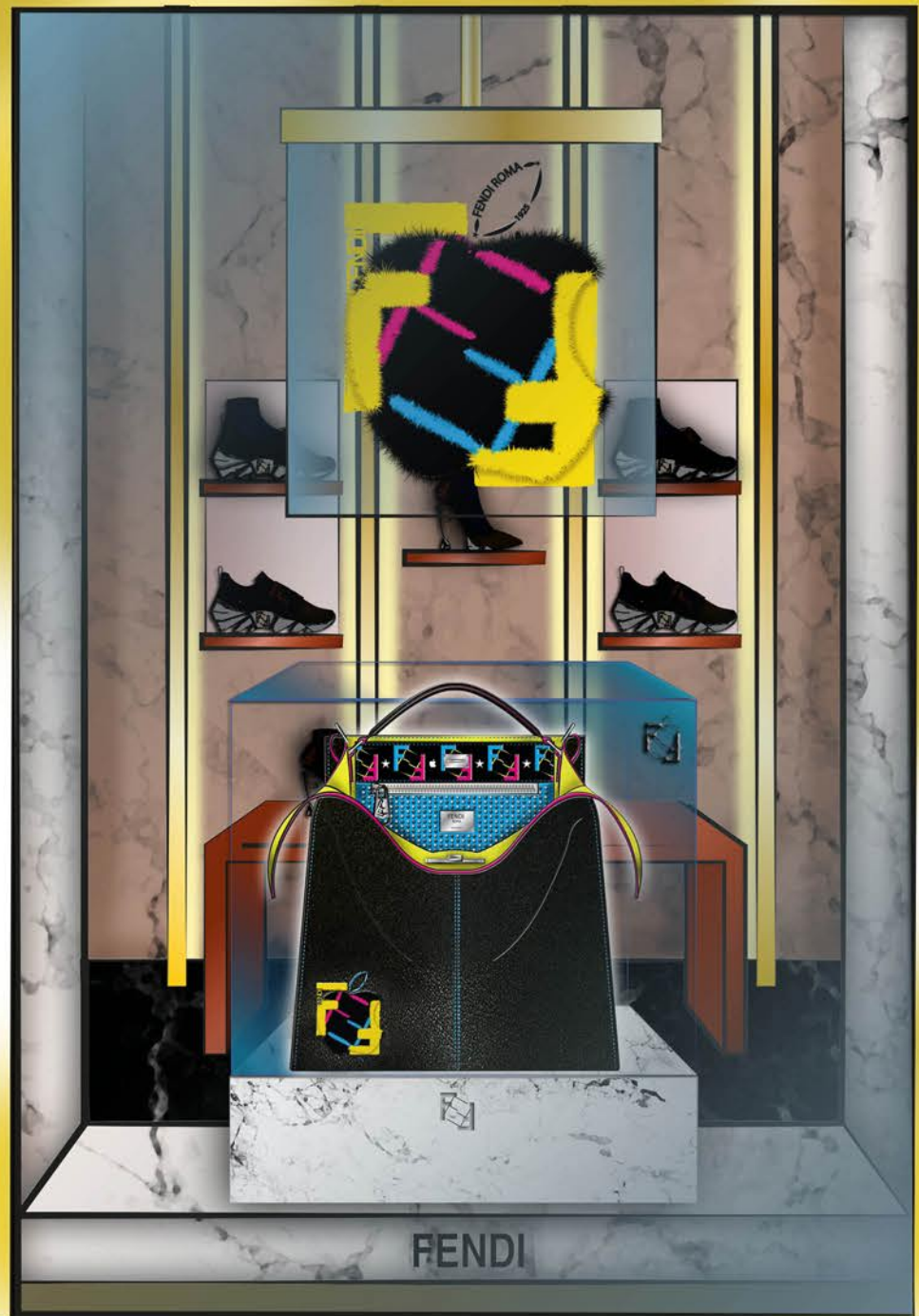

FENDI

ROLLER GYM BAG

Roller bag made in leather.
Zip fastening with double slider and adjustable handles.
Gusset with studs and fur element, embossed FF logo on the body, both in combination with hand made print.

Roller bag made in leather and glazed fabric.
Zip fastening with double slider and adjustable handles.

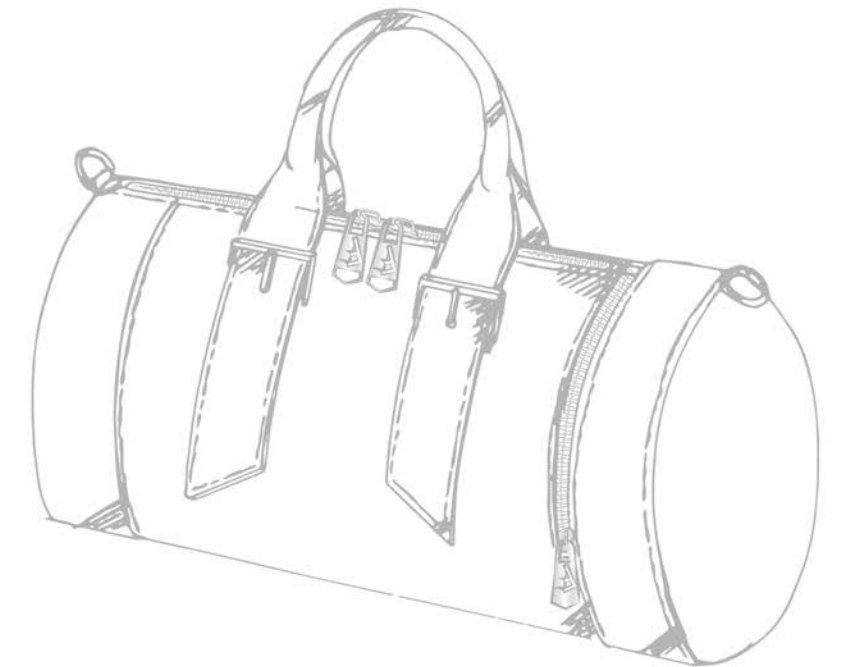



FENDI

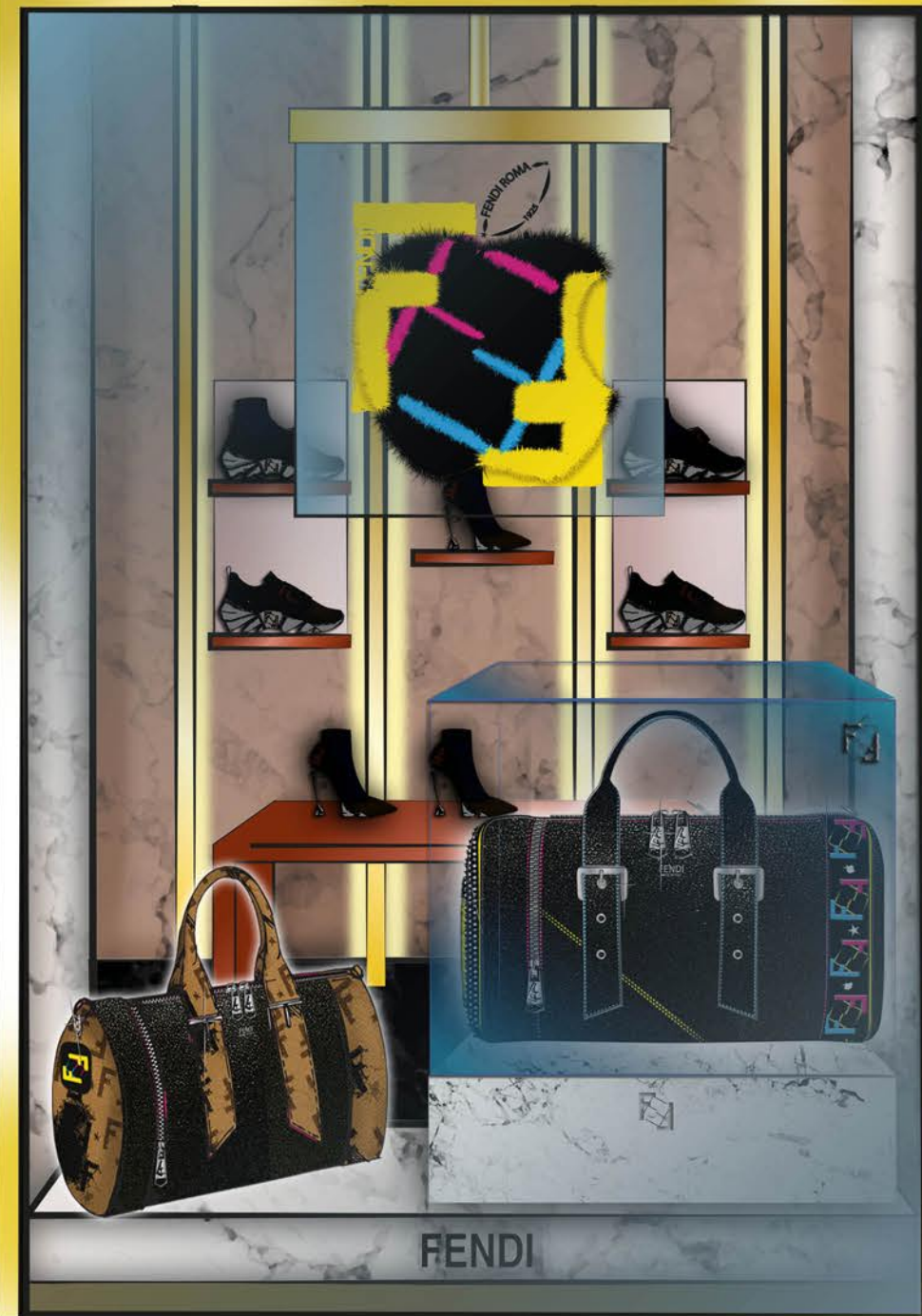

FENDI

FENDI

TRAVEL BAG

Travel bag made in leather.
Zip fastening with double slider and flap
with double FF lock,
Detail of fur in combination with
hand made print;



Travel bag made of glazed fabric and leather.



FENDI

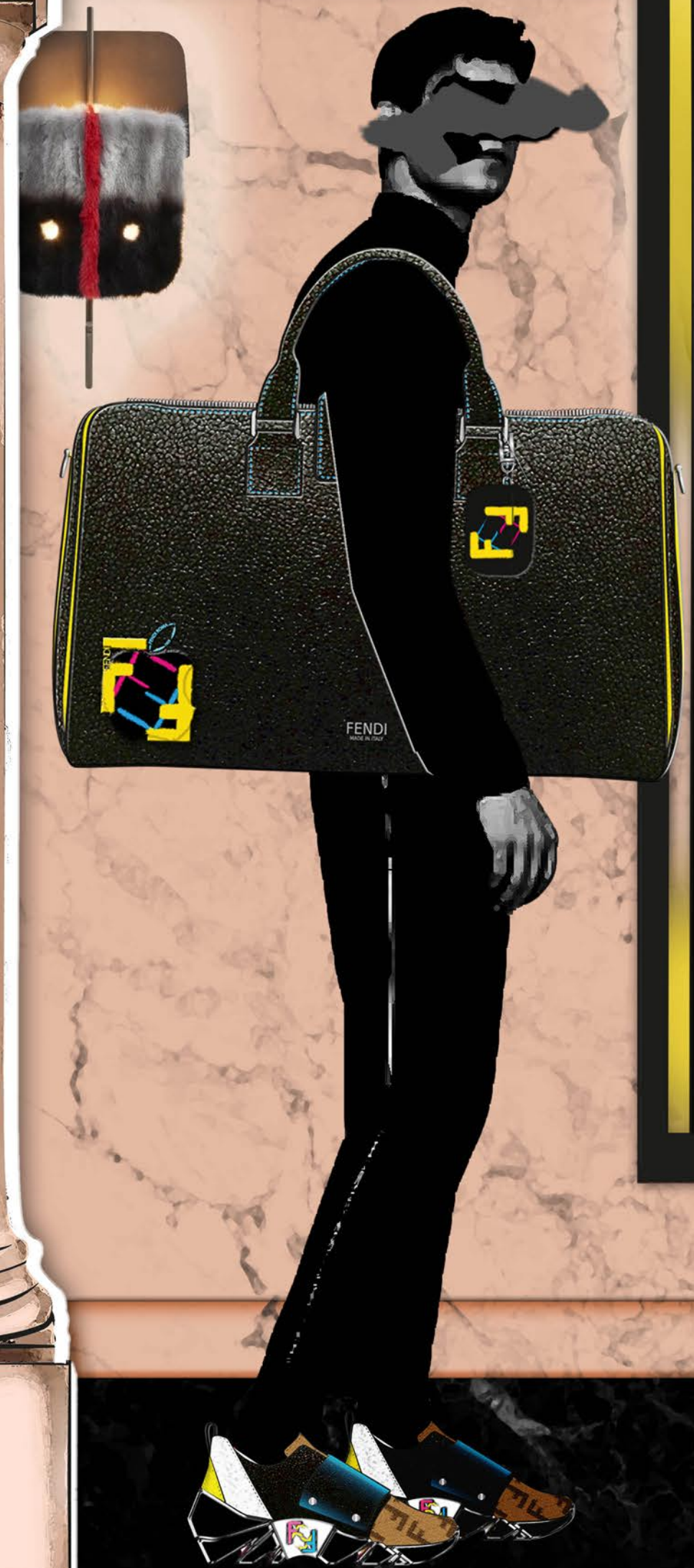
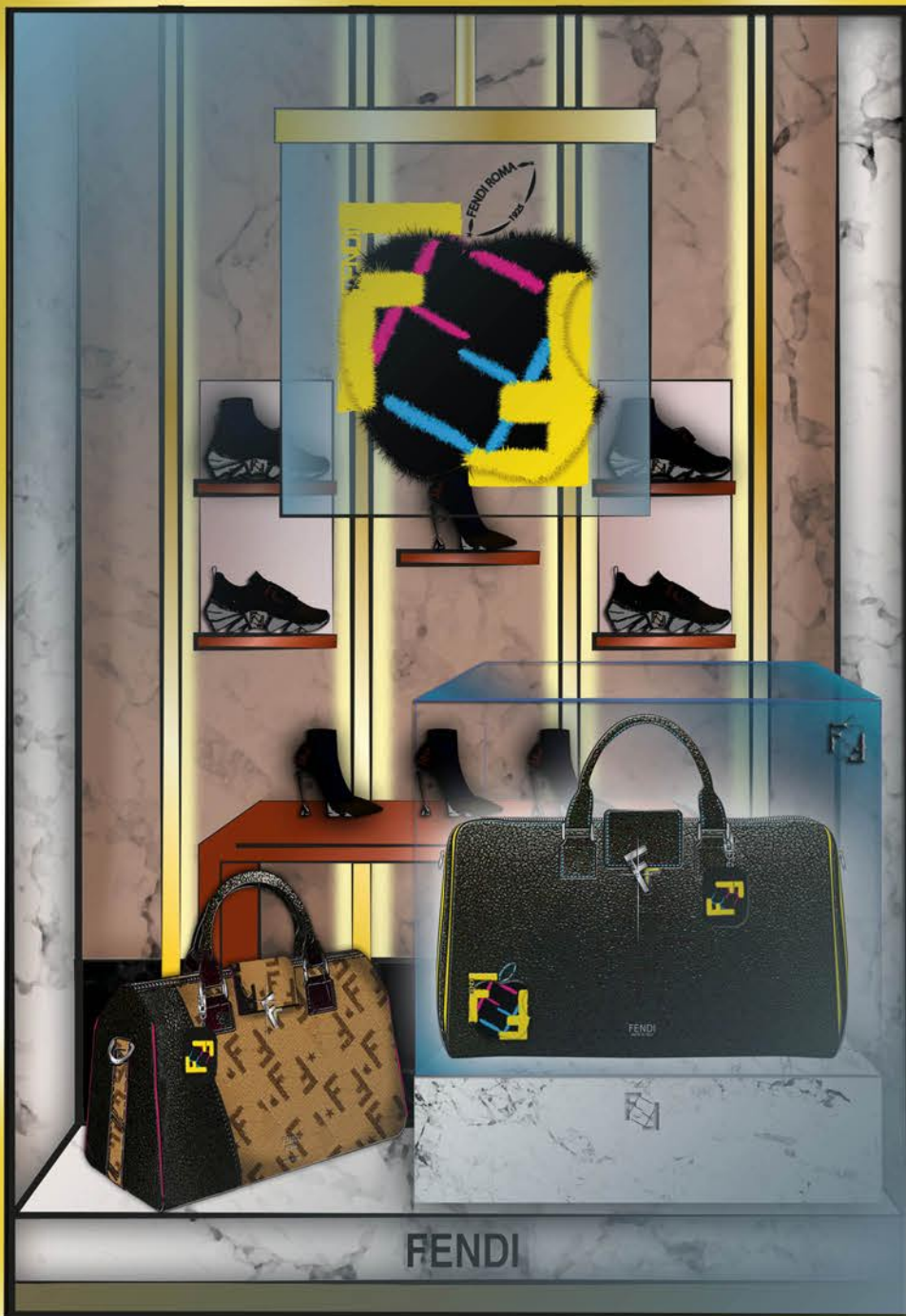

FENDI

RUNNING SNEAKERS

Running sneakers with multilayer wavy soles.
Made of multi leather and stretch tech mesh.
Details FF motif.
PVC strap with fur and hand made print element.

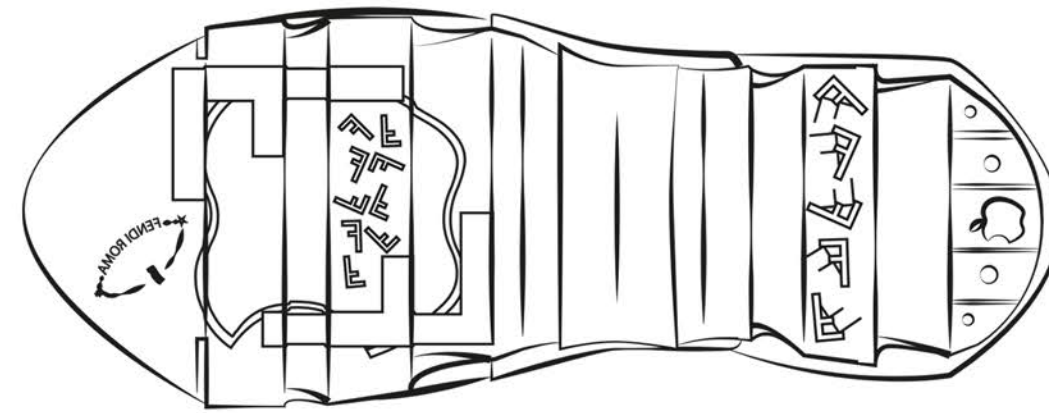

Running sneakers with multilayer wavy soles.
Made of multi leather and FF stretch tech mesh.
PVC strap

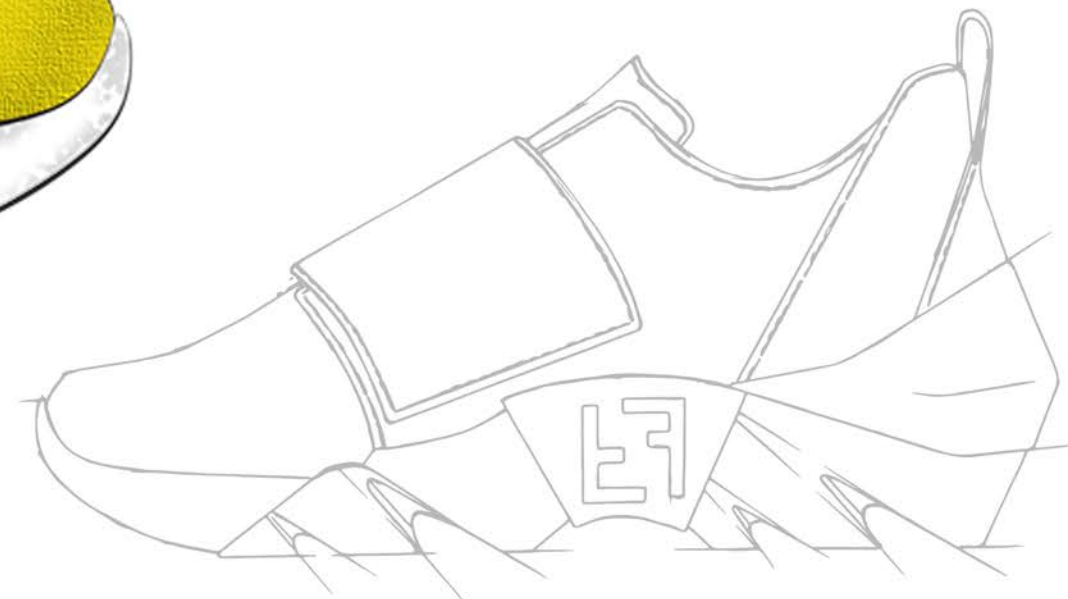

NDI



FENDI

FENDI

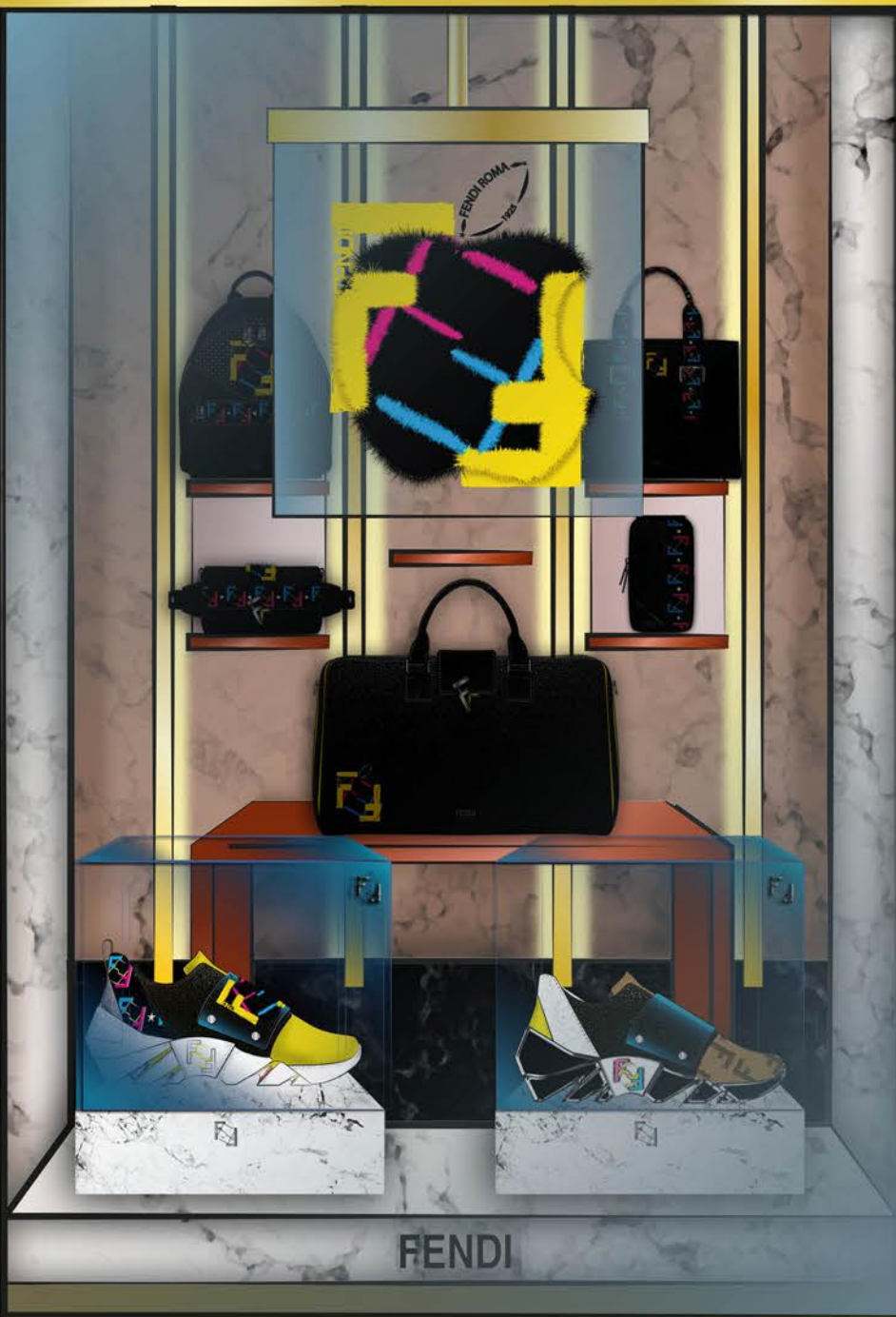

FENDI

FEN



FEN

FENDI

RUNNING SNEAKERS

Running sneakers with a characteristic sock silhouette.
Made of multi leather and stretch knit fabric.
The rubberized film details accentuate the line of the shoe.
Undulated rubber soles and PVC strap with fur and
hand made print element.

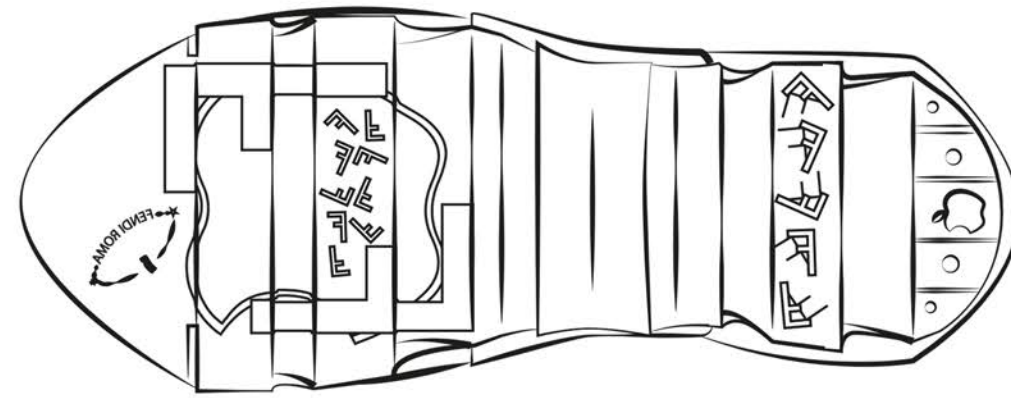

Running sneakers with a characteristic sock silhouette.
Made of multi leather and stretch knit fabric.
The rubberized film details accentuate the line of the shoe.
Undulated rubber soles and PVC strap

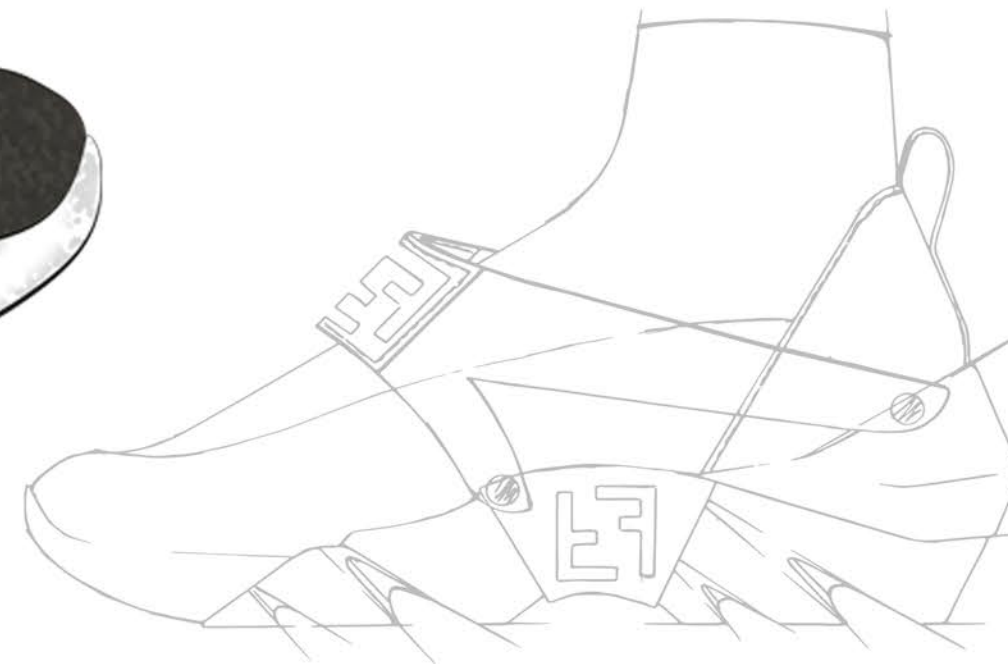
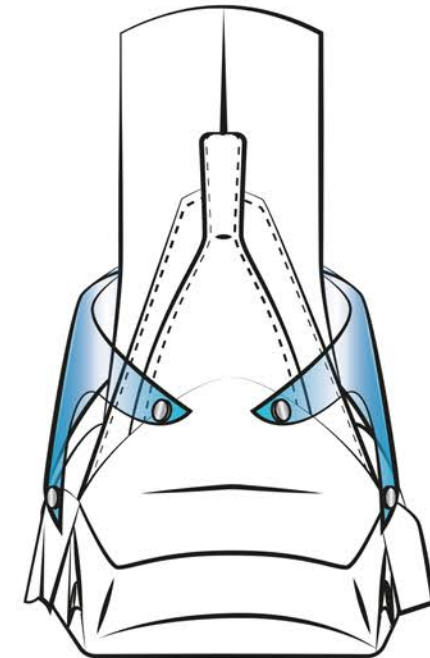
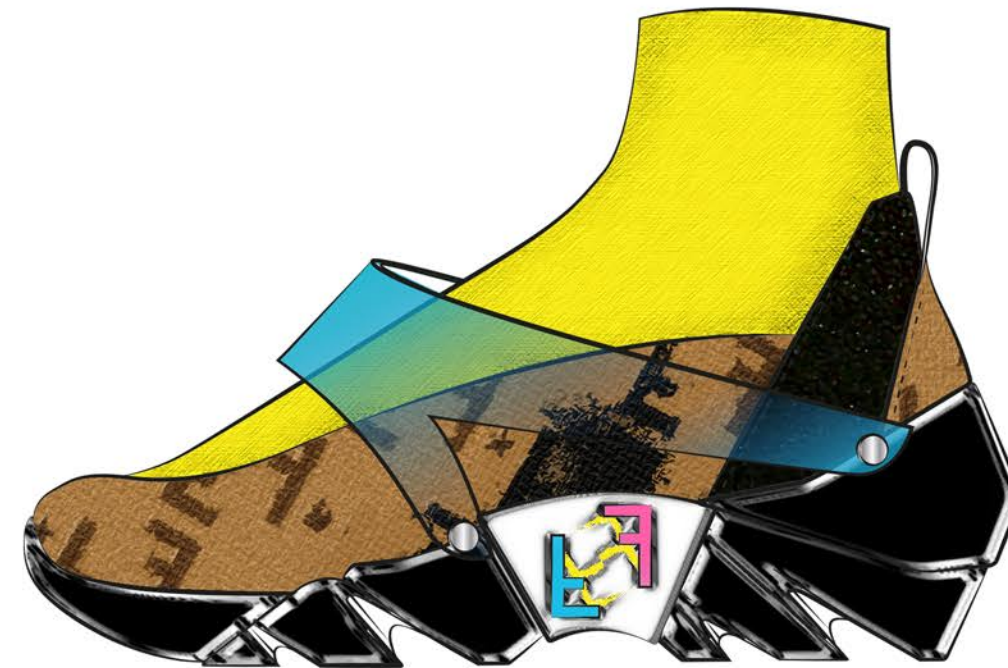
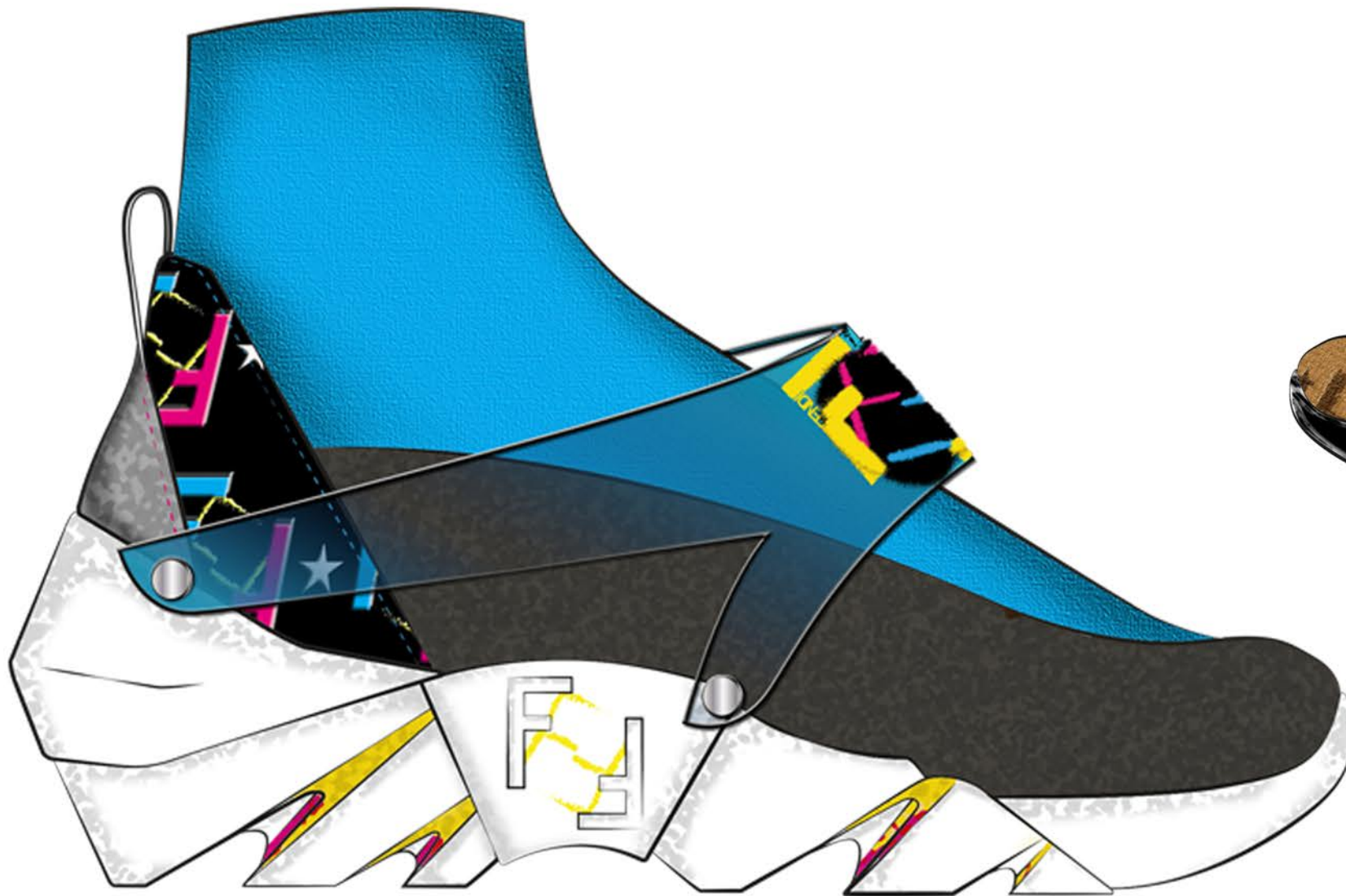

NDI



FENDI

FENDI

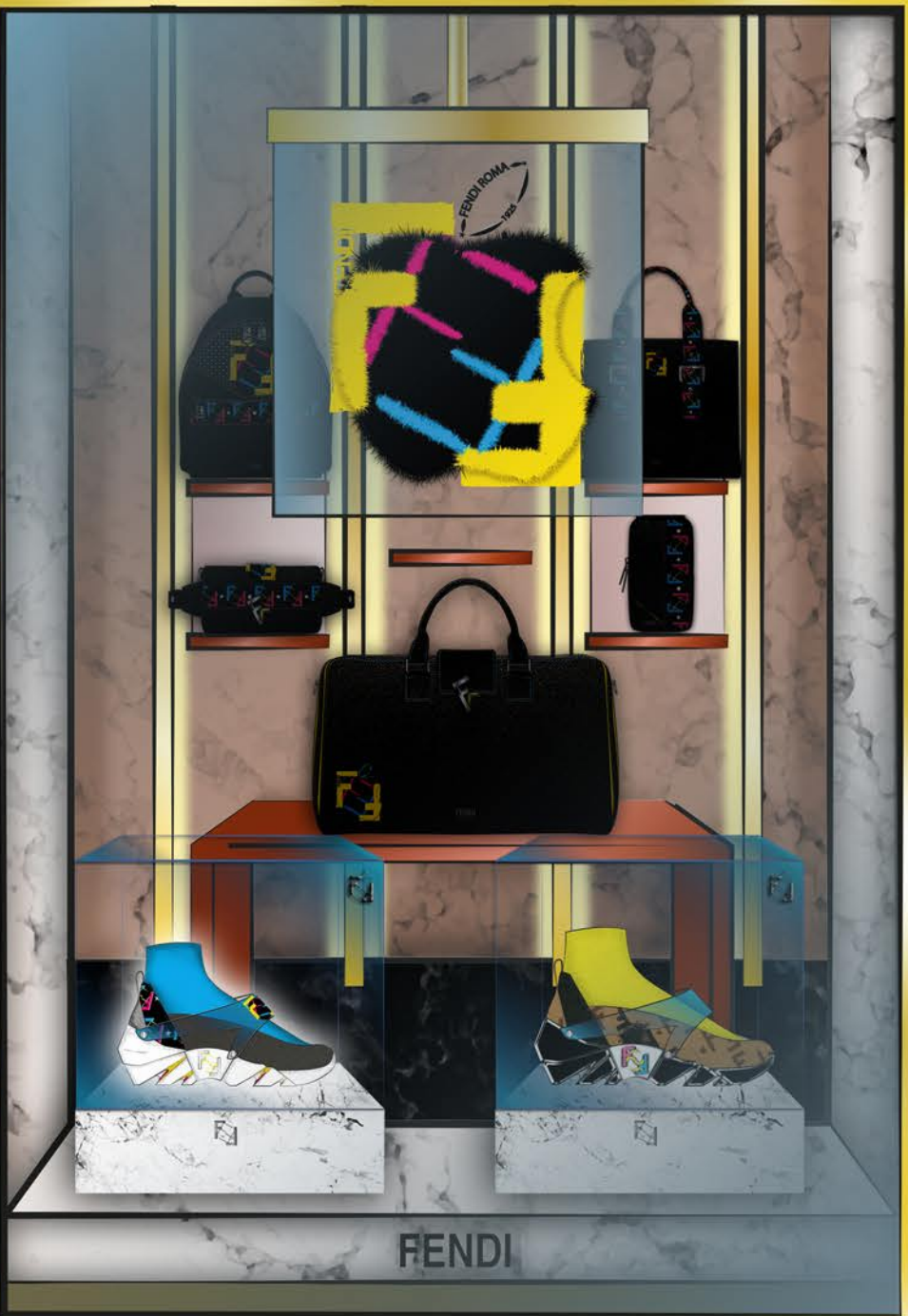

FENDI

FEN



FEN

FENDI

TOP HANDLE BAG

Square bag with top handle made in leather.
Flap closure with double FF lock and details of fur.
Gusseted interior with flat pocket.



Square bag with top handle chain made
in FF print leather .
Flap closure with double FF lock
Gusseted interior with flat pocket.



FENDI

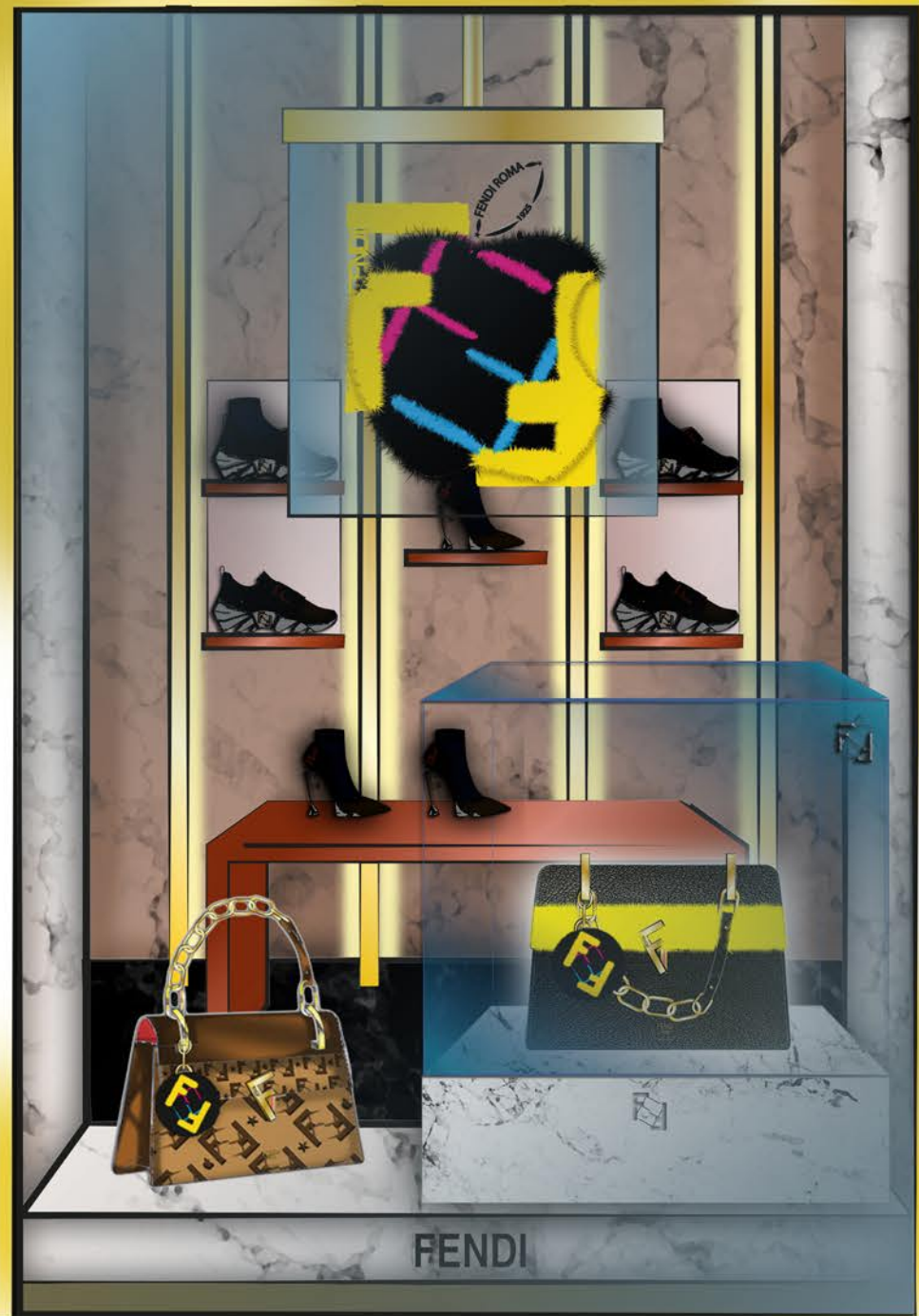

FENDI

FRAME BAG

Square bag with top handle, made in leather with frame closure.
Details of fur on the body .
Gusseted interior in fur with flat pocket.



Square bag with top handle, made in FF print embossed leather with frame closure.
Details of fur on the body .
Gusseted interior in fur with flat pocket.





FENDI

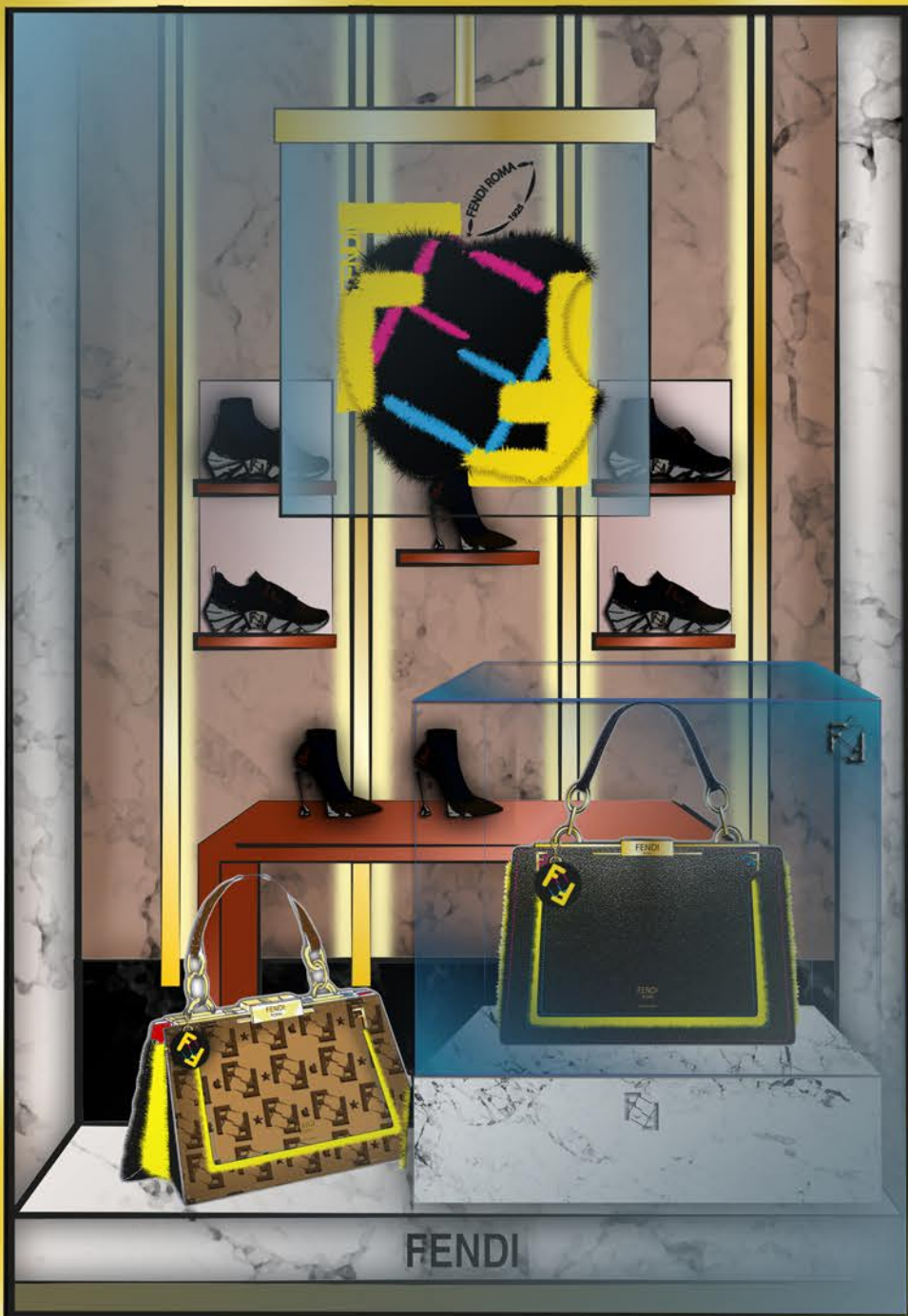

FENDI

FENDI

PUMPS

Pumps with a characteristic sock silhouette.
Made of multi leather and stretch knit fabric.
Characterized of rubber soles and structured heel decorated with PVC F logo.
Details of fur element on back

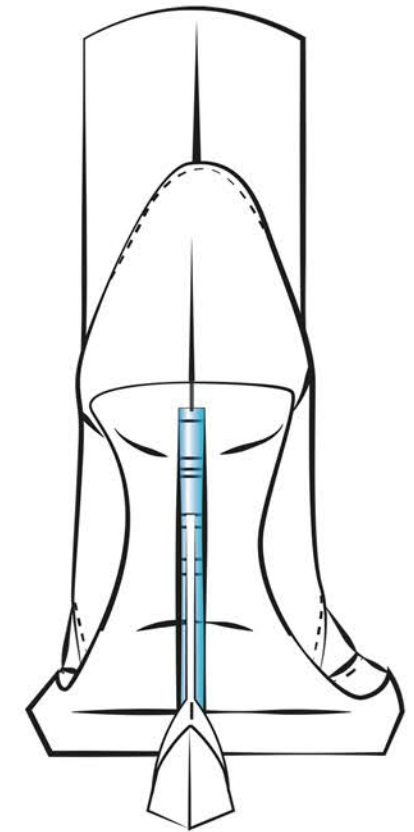

Pumps with a characteristic sock silhouette. Made of multi leather logated and stretch knit fabric.
Characterized of rubber soles and structured heel decorated with PVC F logo.
Details of fur element on back



NDI



FENDI

FENDI

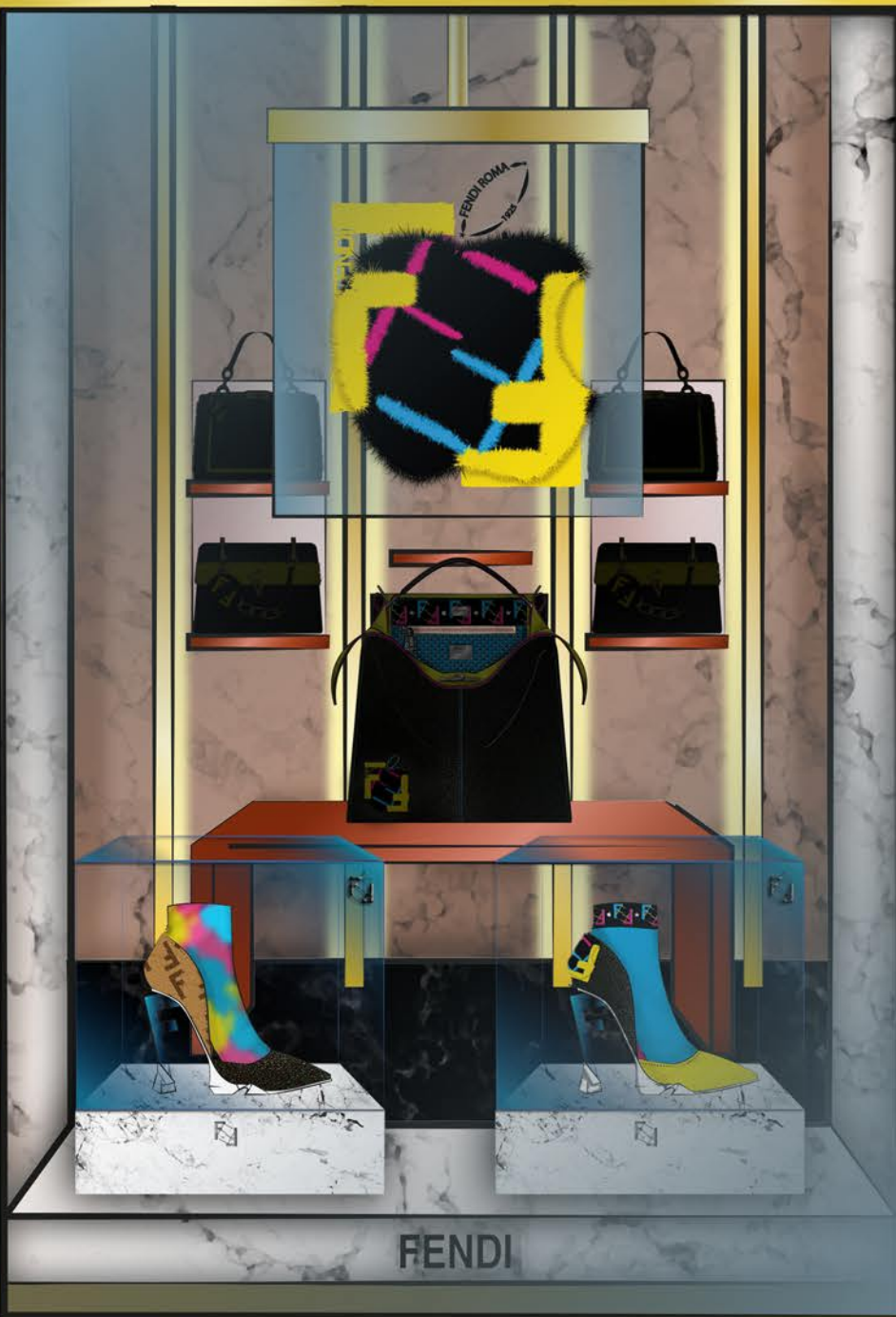

FENDI

FEN



FEN

FENDI

APPLE ACCESSORIES



LINE UP

