



ELEMENT

RESHAPE



VERSACE

M O

O I

VERSACE





CONCEPT

"I think having land and not ruining it is the most beautiful art that anybody could ever want."

Cit. Andy Warhol

A quote that inspired me for the creation of a capsule collection that rides the theme of sustainability.

The focus of the collection is regenerated jeans. Denim, collected through a recycling campaign, is processed and used for the creation of a patch fabric from Japanese culture. The Boro fabric is flanked by leathers, workmanship and hardware conceived and elaborated for the new image of the maison.

"Credo che avere la terra e non rovinarla sia la più bella forma d'arte che si possa desiderare."

Cit. Andy Warhol

Una citazione che mi ha ispirato per l'ideazione di una capsule collection che cavalca il tema della sostenibilità.

Focus della collezione è il jeans rigenerato. Il denim, raccolto attraverso una campagna di riciclo, viene lavorato ed impiegato per la creazione di un tessuto patch proveniente dalla cultura giapponese.

Il tessuto Boro viene affiancato a pellami, lavorazione e hardware pensati ed elaborati per la nuova immagine della maison.

VERSACE

CHART

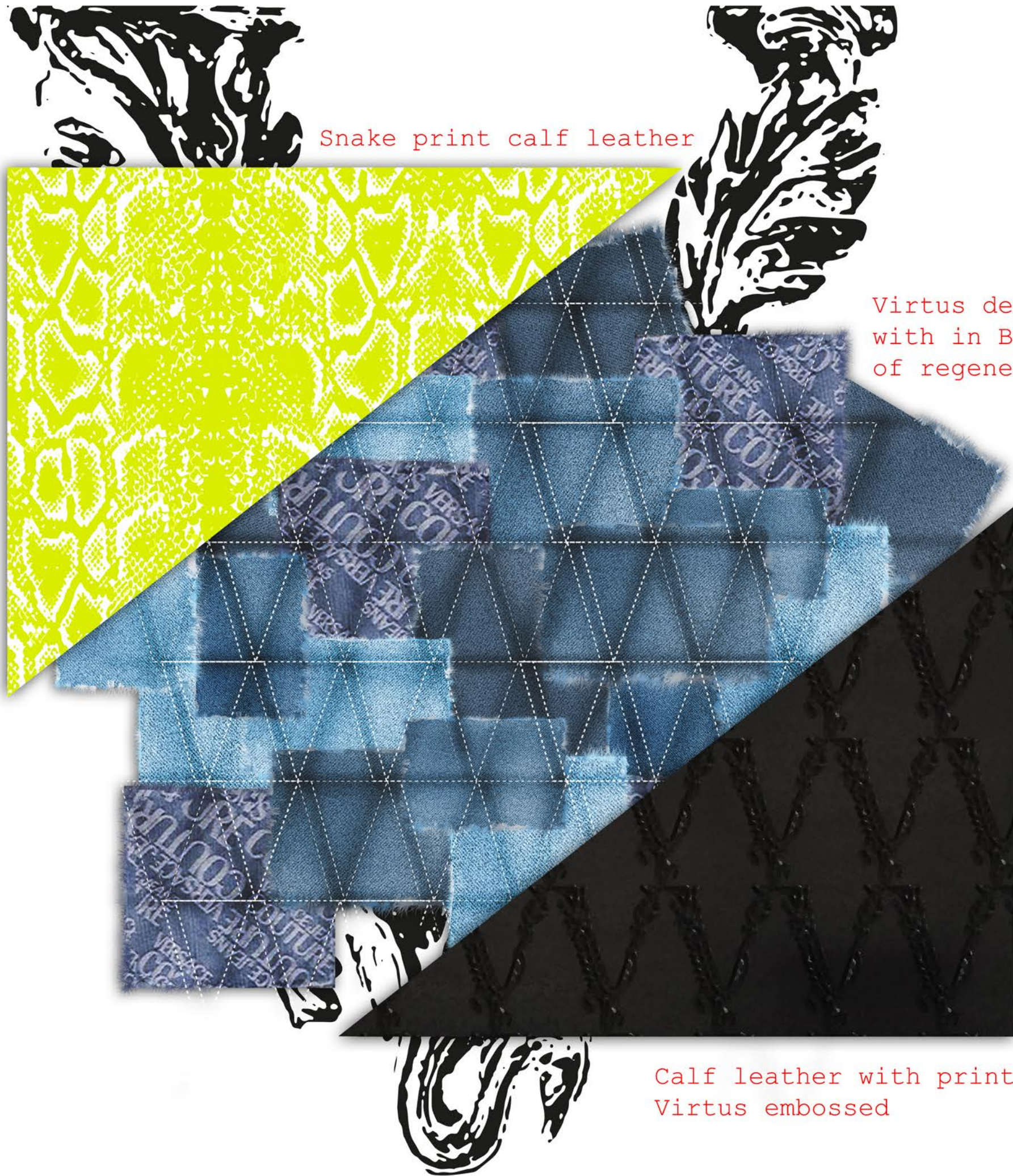

Snake print calf leather

Virtus denim matelasse
with in Boro patch made
of regenerated denim

Calf leather with print
Virtus embossed

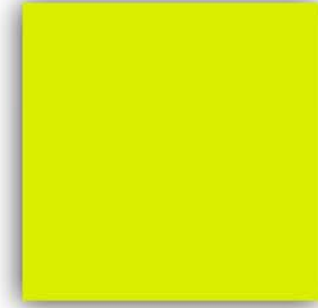

VERSACE



Virtus Lock Closure

Shape of Versace 1969 for embellished lock with pin on side

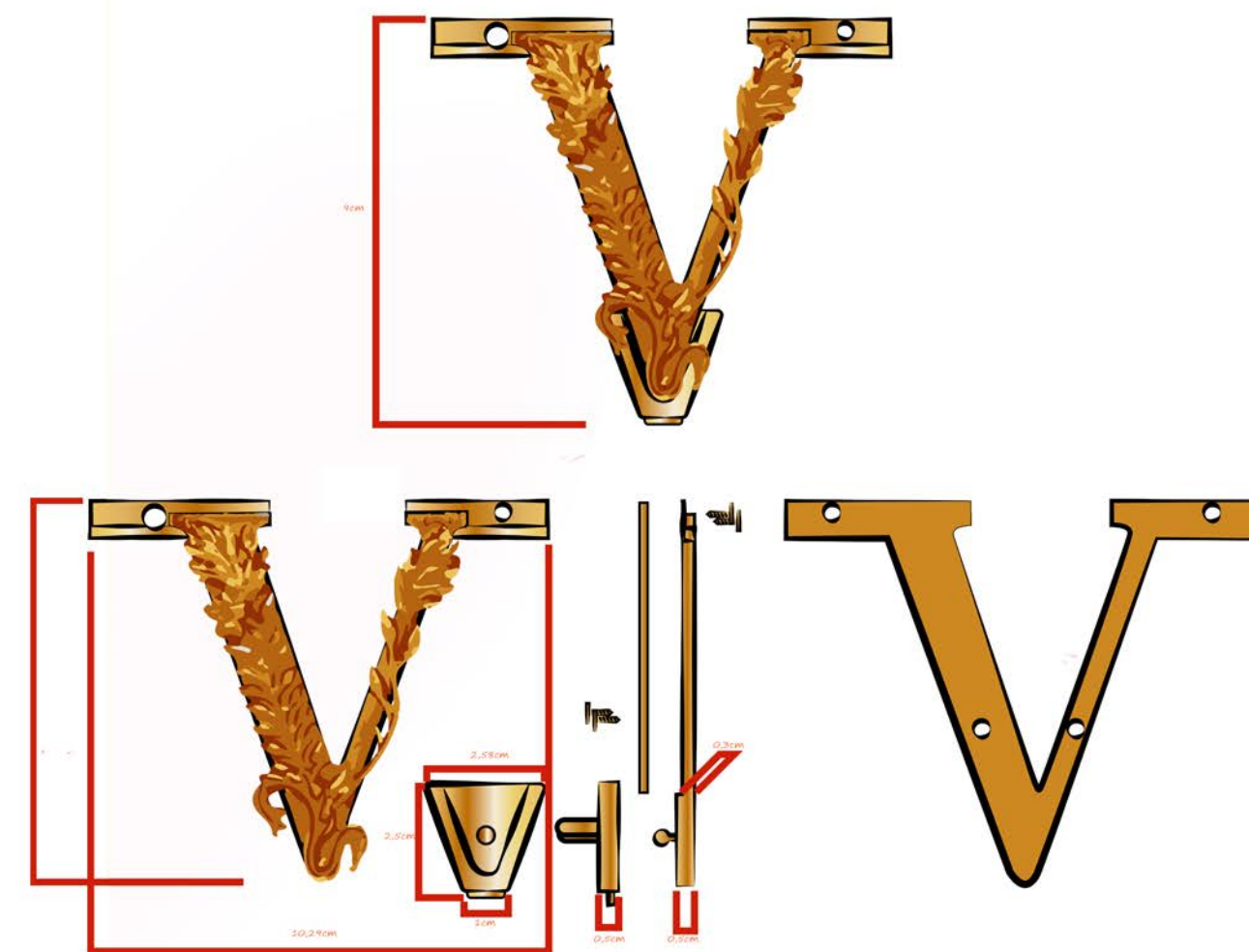

VERSACE

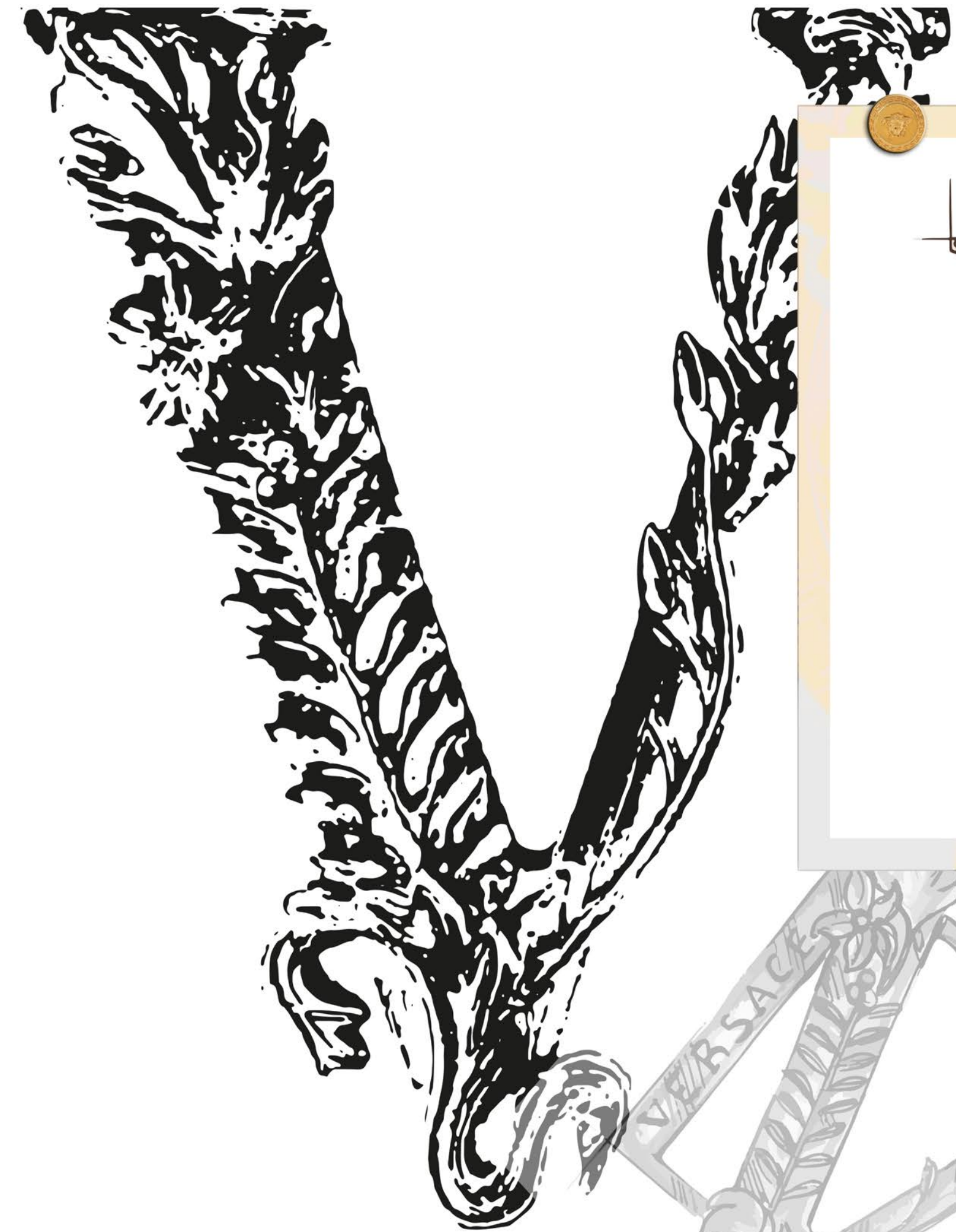

DV Lock Closure

Shape of the Barocco DV monogram with clasp closure

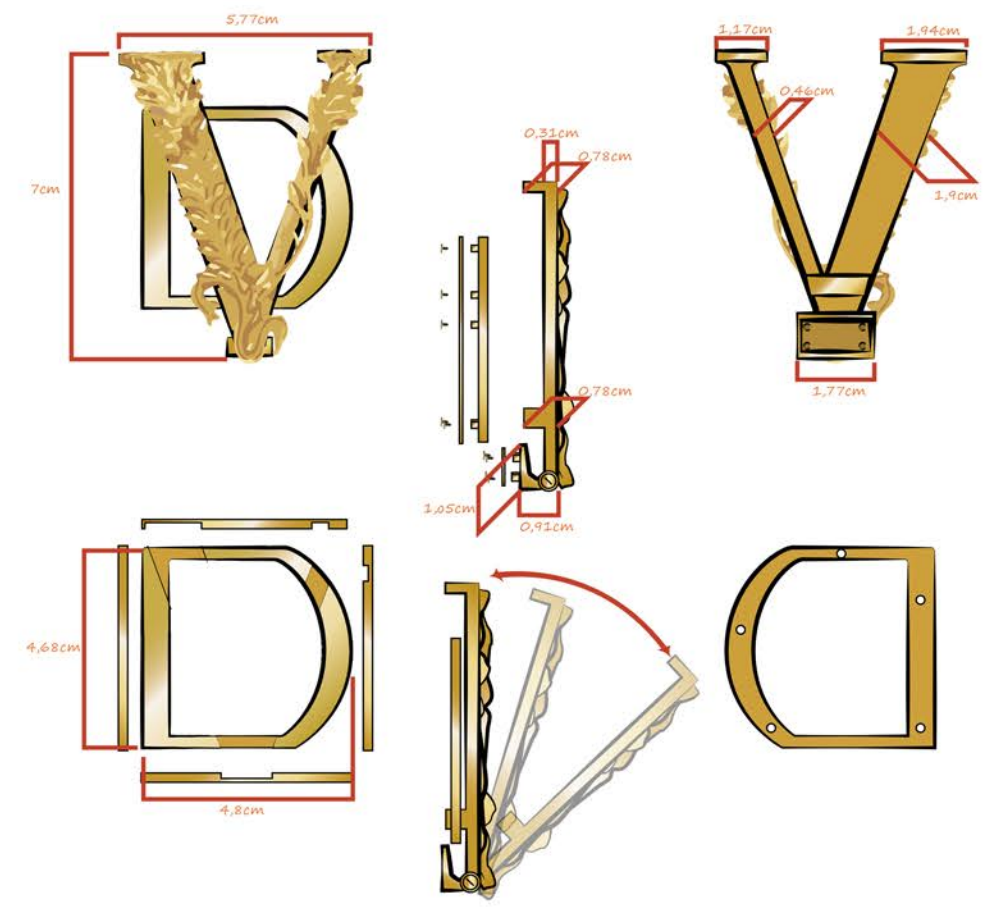

VERSACE



Virtus Lock Closure

Shape of the Barocco V letter monogram for embellished with magnet tab on side

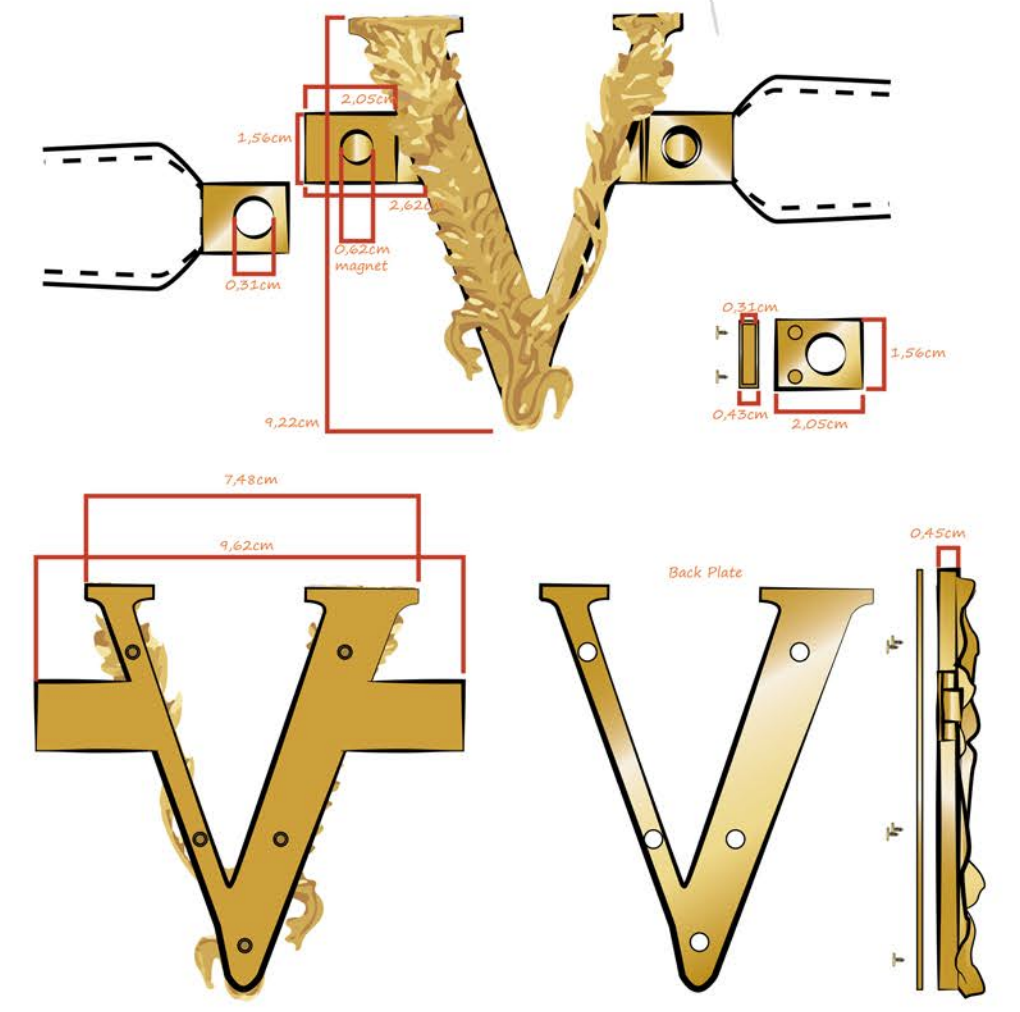

VERSACE

Virtus Snap-hook

Shape of the Barocco letter V embellished for shoulder strap

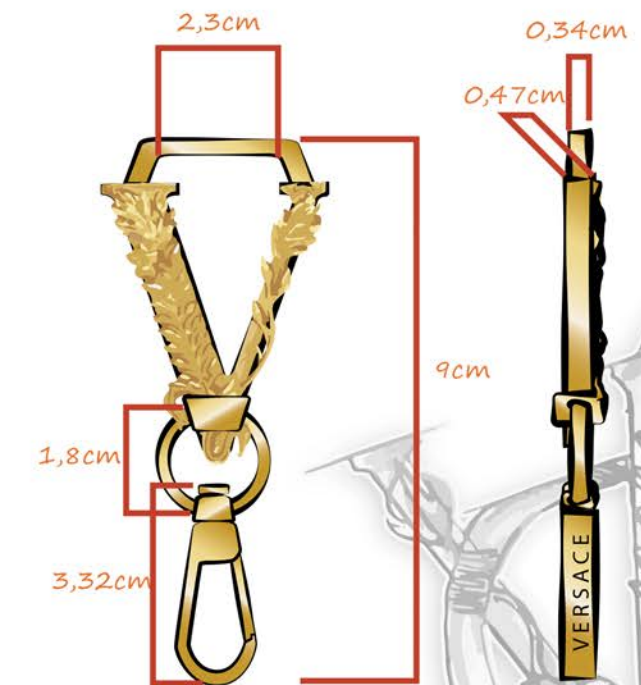
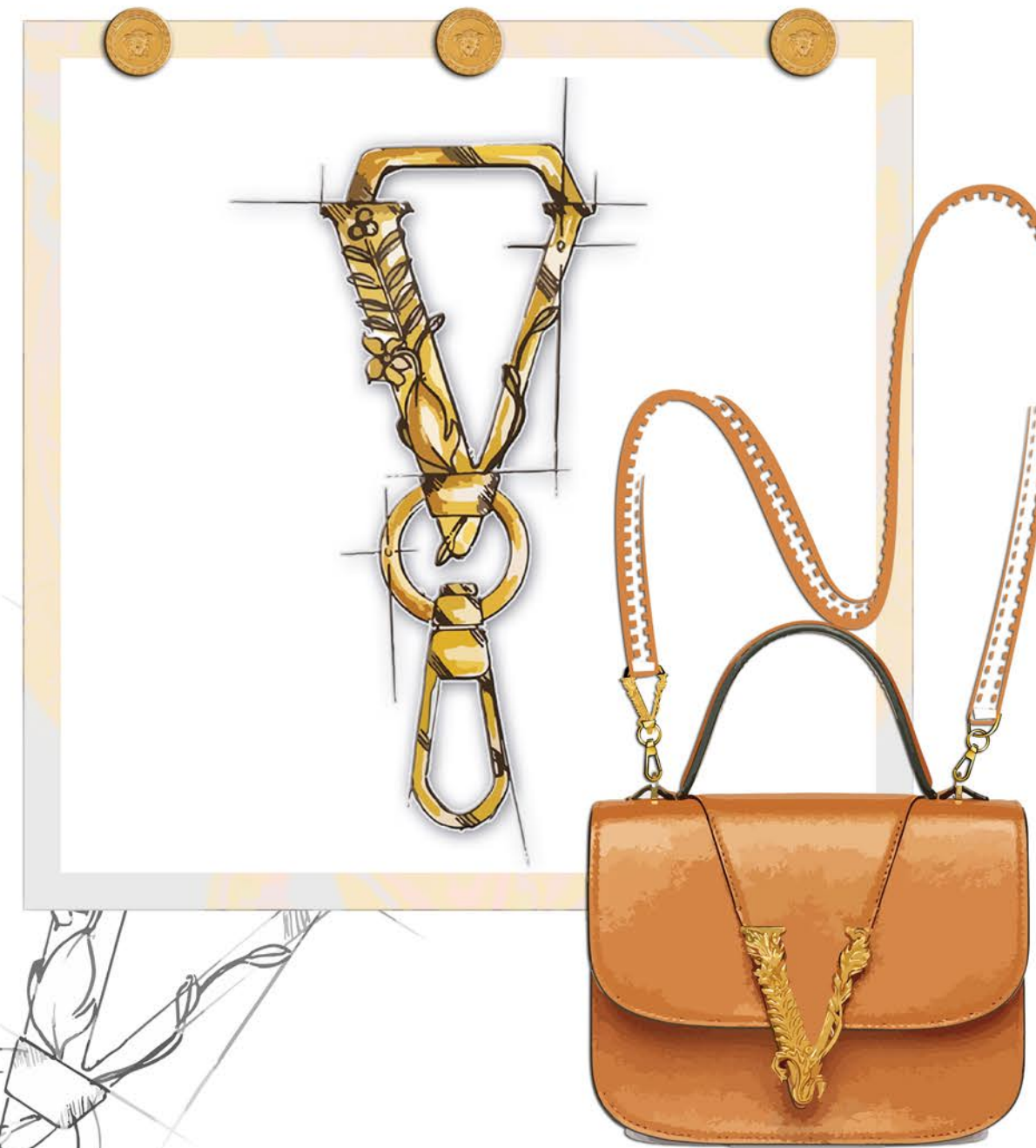

DV Snap-hook

Shape "DV" in Baroque lettering, embellished for chain shoulder strap

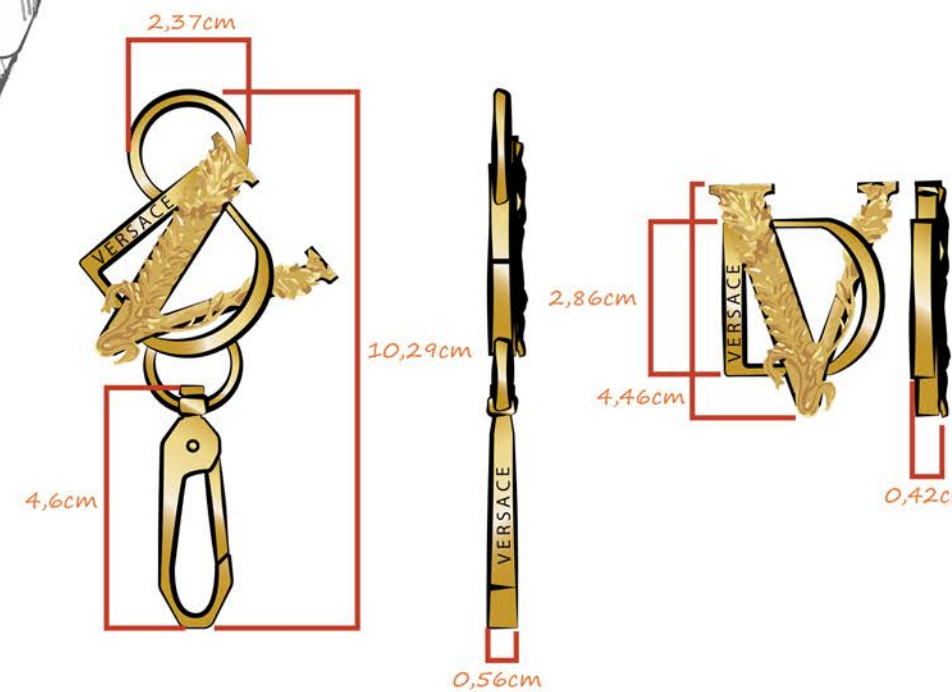

VERSACE

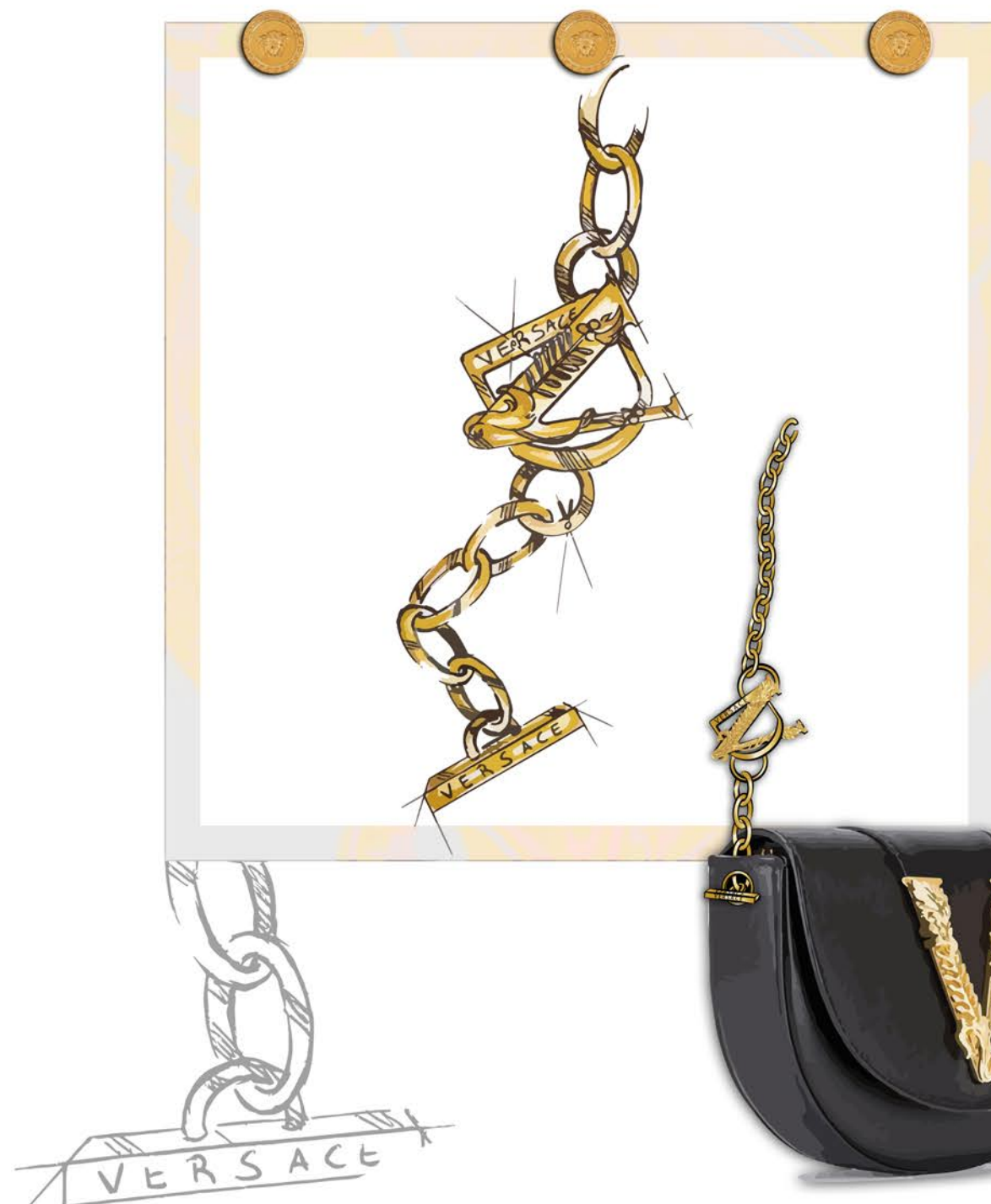

DV Hardware

Shape of the Barocco DV monogram for embellished chain shoulder bag with a T bar at the end

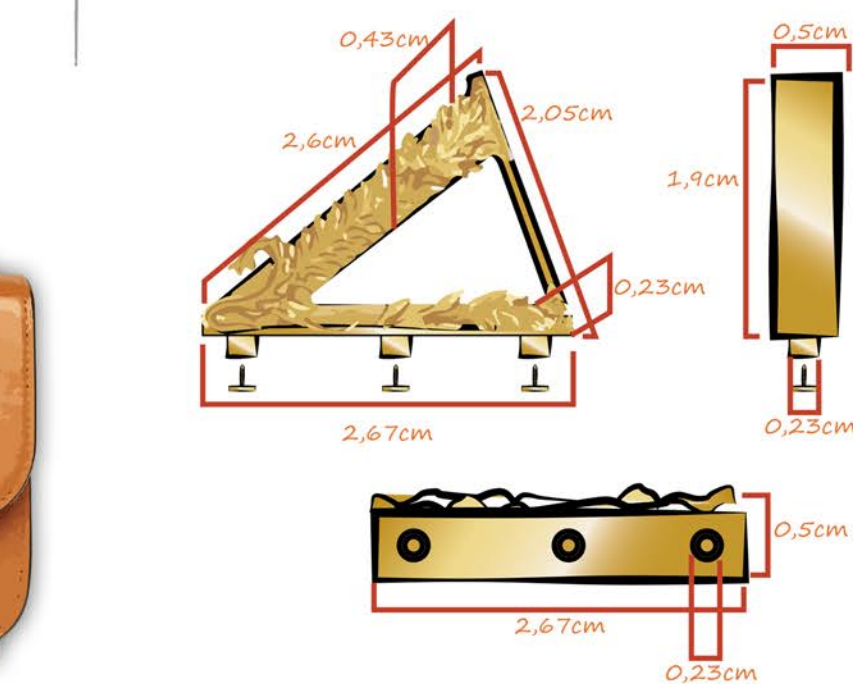
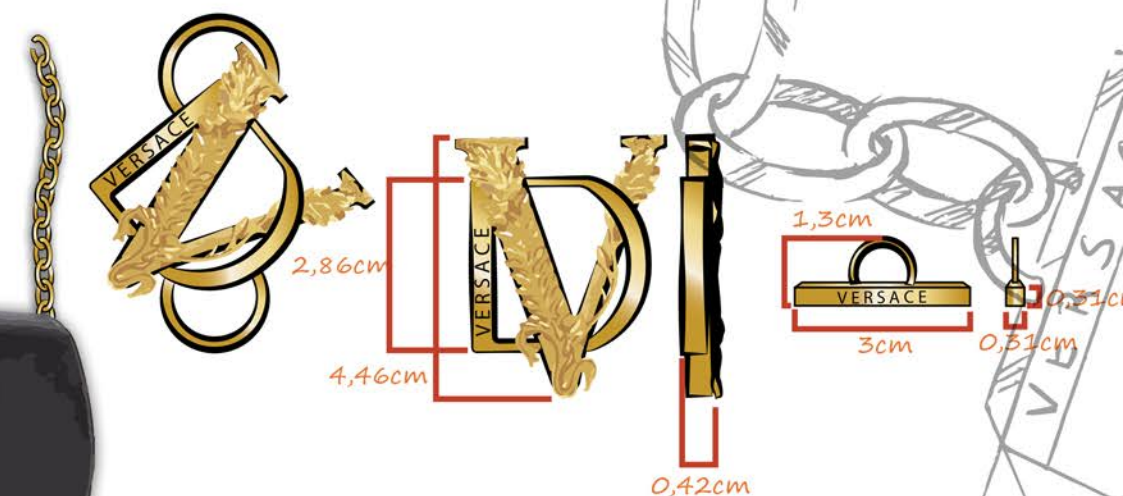

Virtus Metal Bridge

Metal bridge with shape of the barocco letter "V"

VERSACE

BELT BAG

Belt bag made of matelasse boro patch for the body,
flap and belt made with snake print leather.
Lock with a shape of Virtus Versace logo from 1960 and
Versace studs



VERSACE

SHOULDER BAG

Mini bag with double wear made of snake print leather for the body.
Flap made of matelasse boro patch and snake print leather.
Lock with shape logo from 1960, studs and can charm.

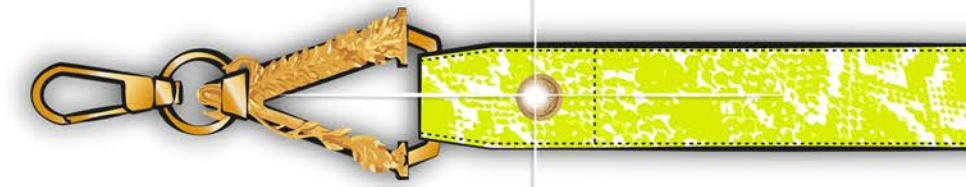
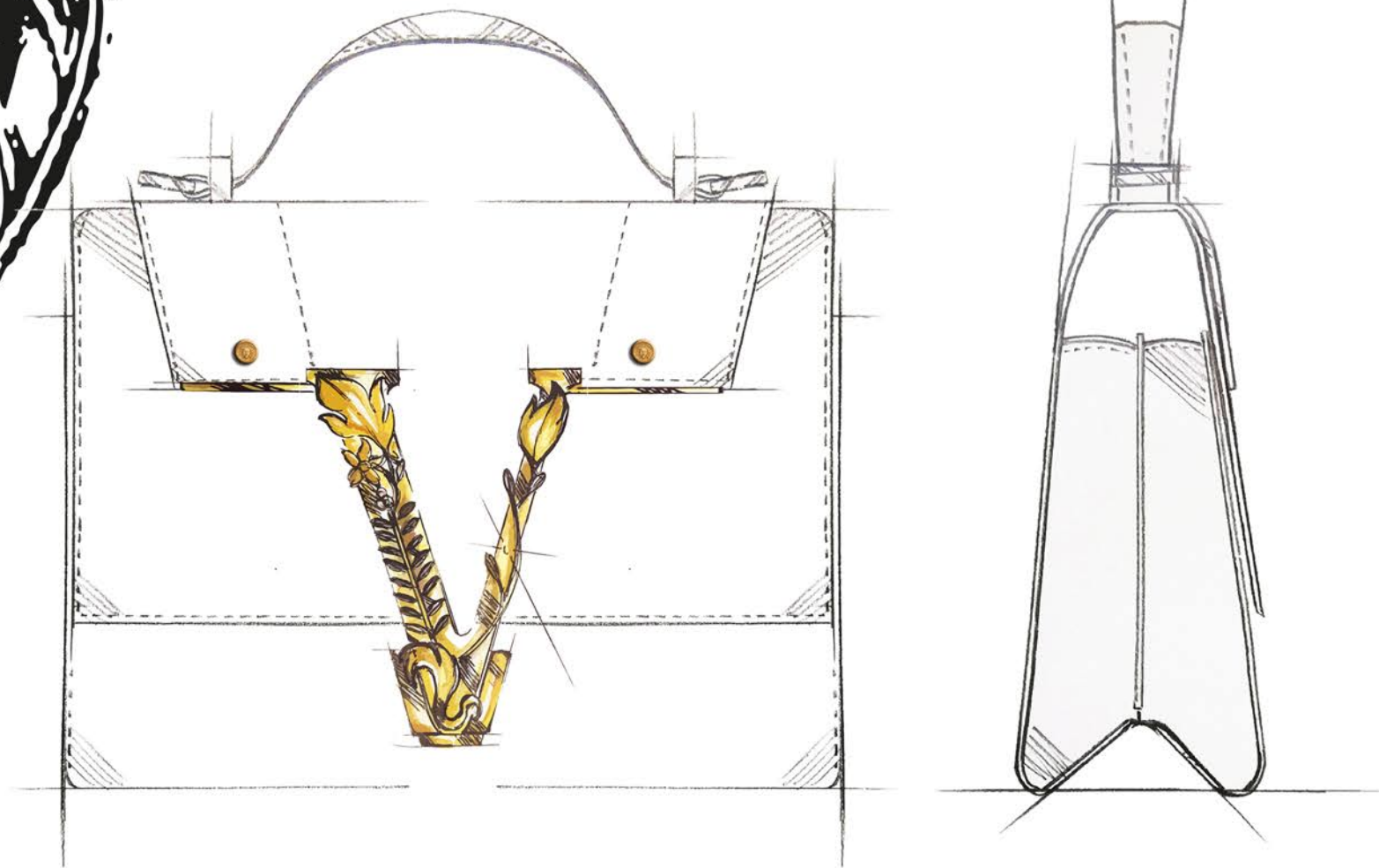

VERSACE

TOTE BAG

Large handle bag made of matelasse boro patch for the body, gussets and flap made with snake print leather. Lock with shape of Virtus Versace logo from 1960, Versace studs and can charm.



VERSACE

BELT BAG

Mini bag with double wear made of matelasse boro patch and virtus embossed for the body, flap made with snake print leather. Lock and chain embellished with Virtus monogram Donatella Versace shape

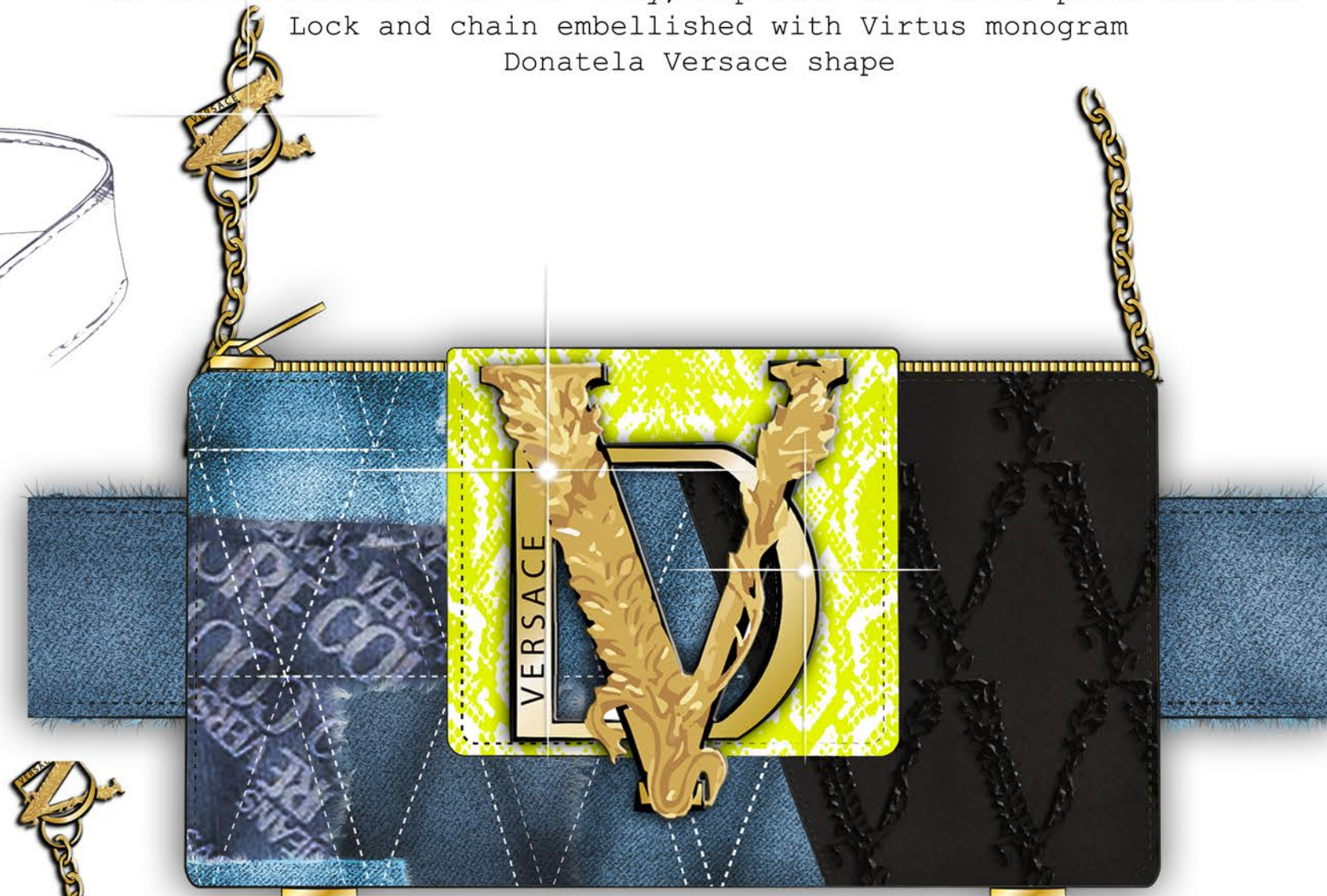
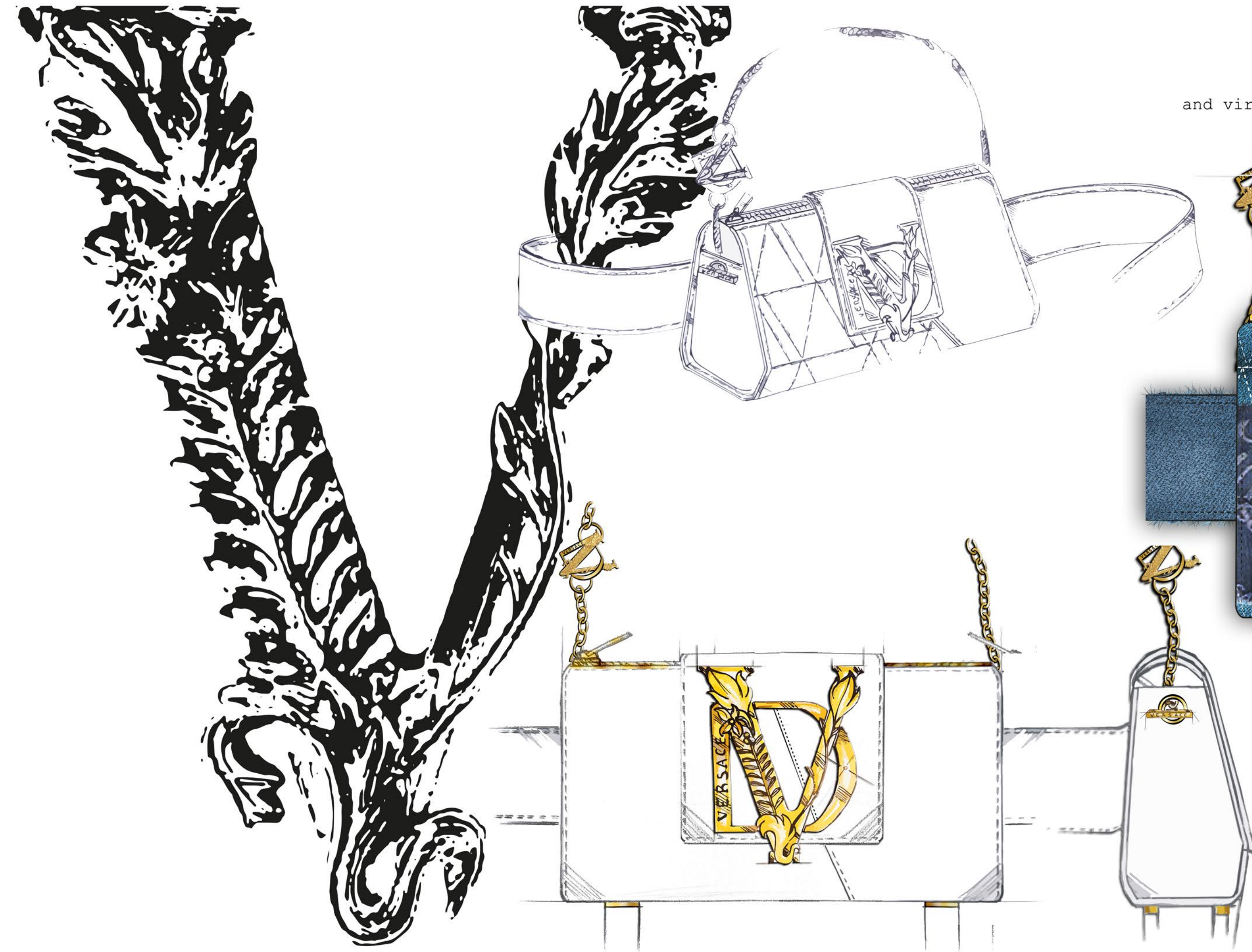

VERSACE

SHOULDER BAG

Shoulder bag made of matelasse boro patch and leather with print Virtus embossed for the body.
Flap made of snake print leather.
Lock and chain of the handle embellished with shape of Virtus monogram Donatella Versace.



VERSACE

SHOULDER BAG

Shoulder bag made of matelasse boro patch and leather with print Virtus embossed for the body.
Flap made of snake print leather.
Lock and chain of the handle embellished with shape of Virtus monogram Donatella Versace.



VERSACE

TOTE BAG

Handles bag made of matelasse boro patch, leather with print
Virtus embossed and snake print for the body,
flap made of snake print leather.
Lock with shape of Donatella Virtus Versace monogram.

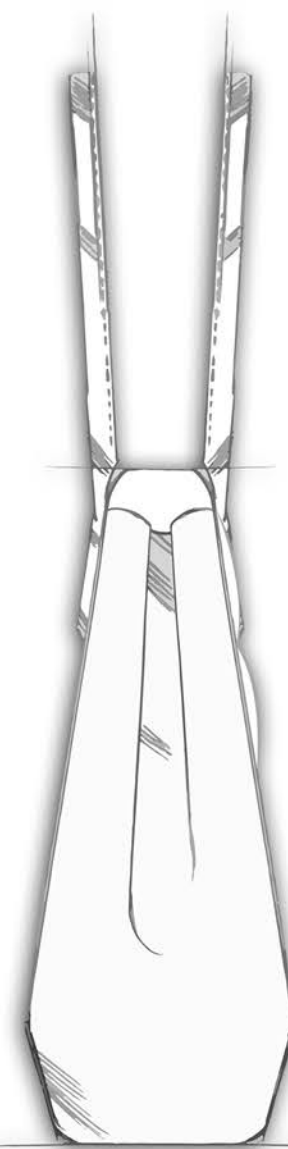

VERSACE

SMALL HANDLE BAG

Small bag made of leather with print Virtus embossed and snake print leather for the body, flap and belt of the lock in denim. Lock with shape of Virtus Versace monogram.

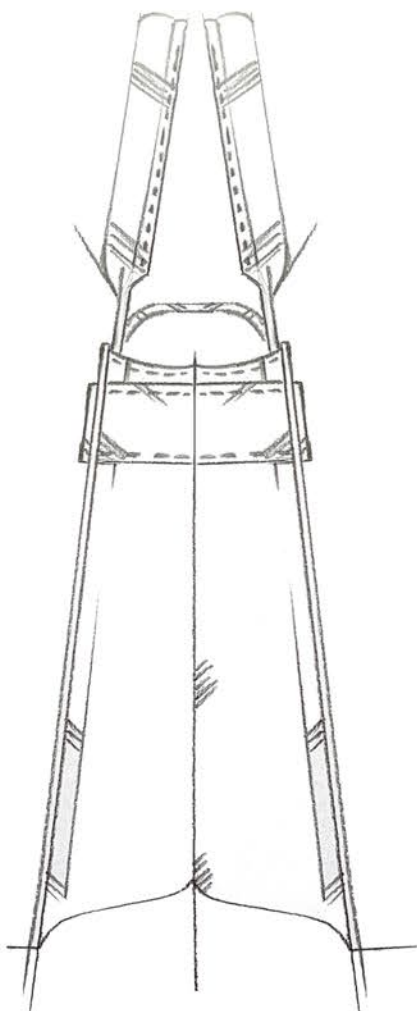

VERSACE

HANDLE BAG

Handle bag made of leather with print Virtus embossed for the body, flap made with snake print leather and denim for gussets, handle and belt of the lock.

Lock and side bridge with shape of Virtus Versace monogram.



VERSACE

SHOPPING BAG

Shopping bag made of leather with print Virtus embossed and snake print leather for the body. Danim for the flap, the gussets, the handles and the belt of the lock. Lock and side bridge with shape of Virtus Versace monogram.



VERSACE

SMALL GOODS

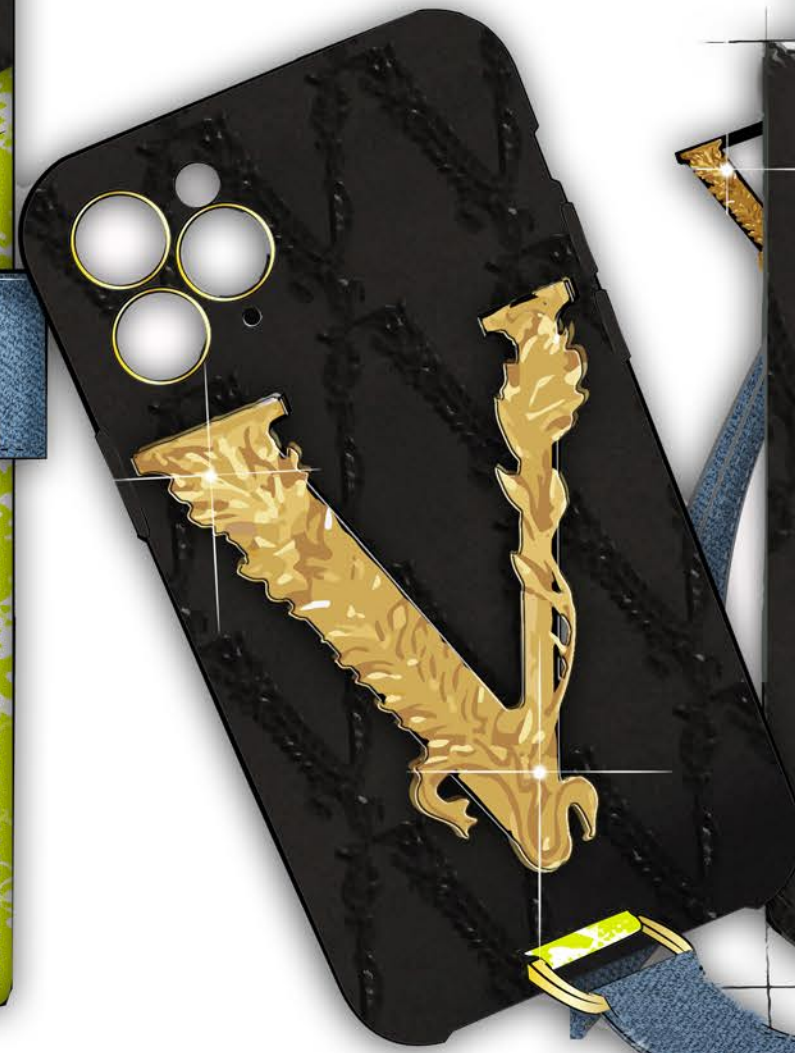
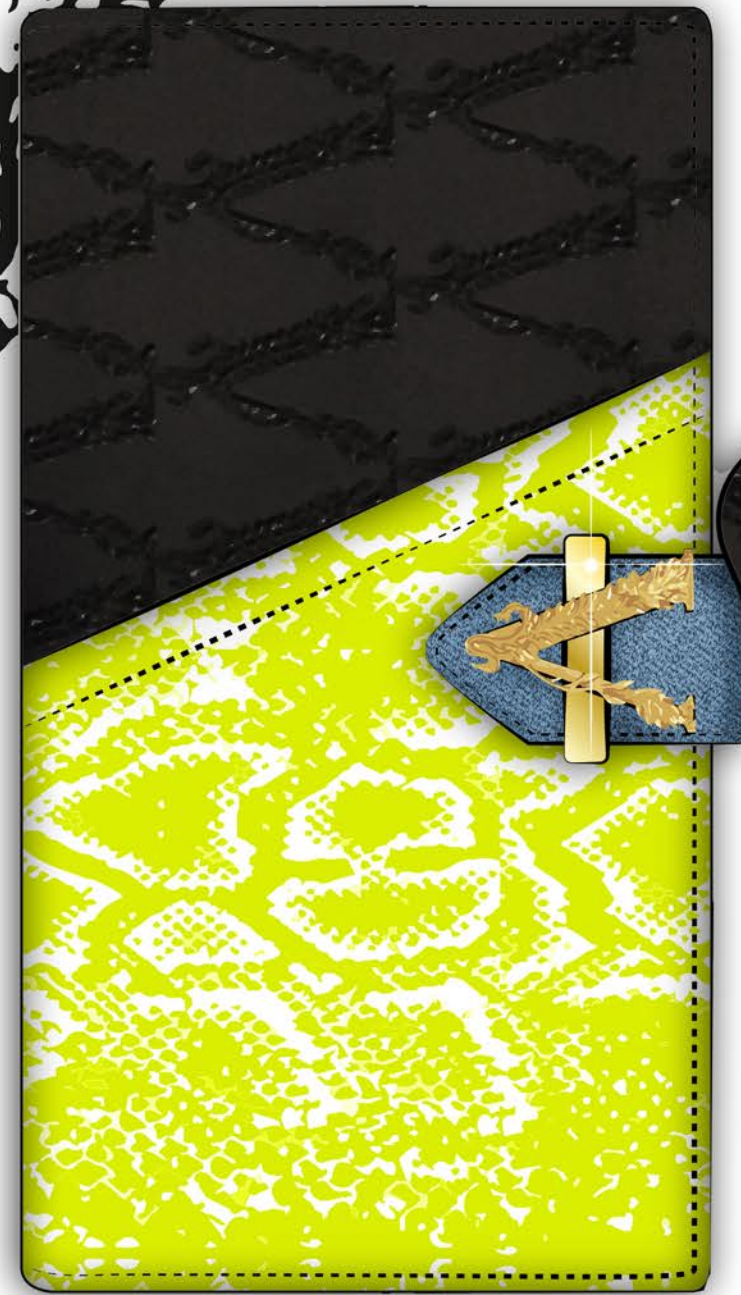

VERSACE

WALLET

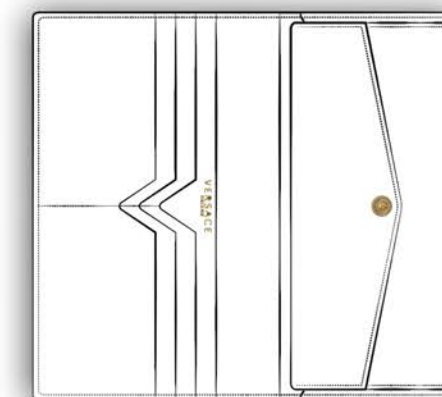
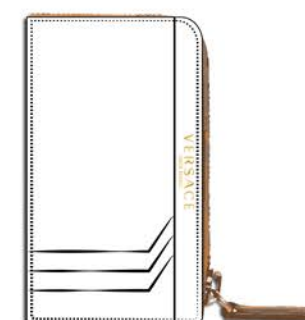

VERSACE

FOULARD

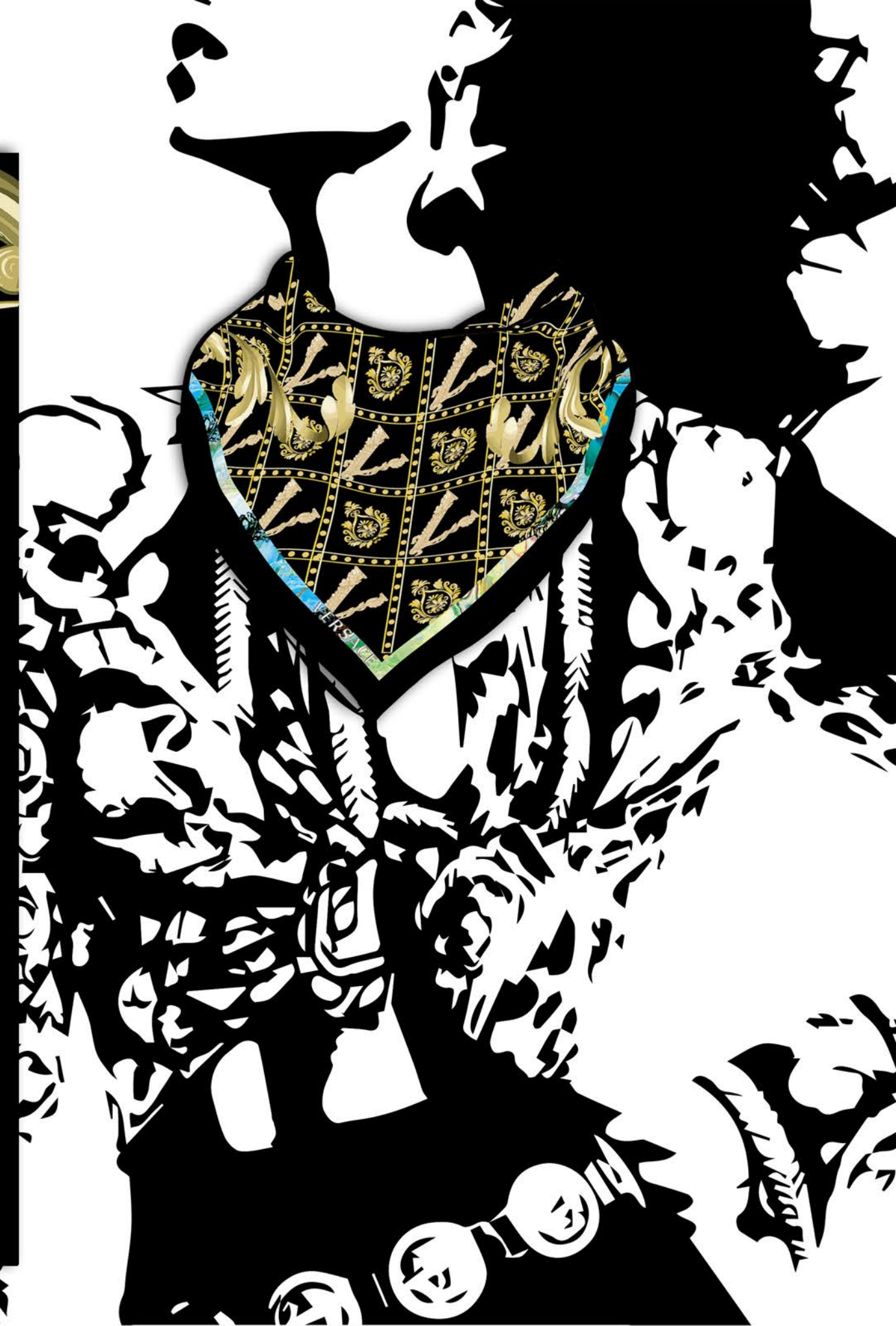

VERSACE

IPHONE CASES



VERSACE

FOULARD



VERSACE

CHARMS AND KEY RINGS



VERSACE